

# **TravelMate 7520/7520G/7220 Series Aspire 7420/7120 Series Service Guide**

Service guide files and updates are available on the ACER/CSD web; for more information, please refer to <http://csd.acer.com.tw>

PRINTED IN TAIWAN

---

## Revision History

Please refer to the table below for the updates made on TravelMate 7520/7520G/7220 Series and Aspire 7420/7120 Series service guide.

Date	Chapter	Updates

---

## Copyright

Copyright © 2007 by Acer Incorporated. All rights reserved. No part of this publication may be reproduced, transmitted, transcribed, stored in a retrieval system, or translated into any language or computer language, in any form or by any means, electronic, mechanical, magnetic, optical, chemical, manual or otherwise, without the prior written permission of Acer Incorporated.

## Disclaimer

The information in this guide is subject to change without notice.

Acer Incorporated makes no representations or warranties, either expressed or implied, with respect to the contents hereof and specifically disclaims any warranties of merchantability or fitness for any particular purpose. Any Acer Incorporated software described in this manual is sold or licensed "as is". Should the programs prove defective following their purchase, the buyer (and not Acer Incorporated, its distributor, or its dealer) assumes the entire cost of all necessary servicing, repair, and any incidental or consequential damages resulting from any defect in the software.

Acer is a registered trademark of Acer Corporation.

Intel is a registered trademark of Intel Corporation.

Pentium and Pentium II/III are trademarks of Intel Corporation.

Other brand and product names are trademarks and/or registered trademarks of their respective holders.

---

## Conventions

The following conventions are used in this manual:

<b>SCREEN MESSAGES</b>	Denotes actual messages that appear on screen.
<b>NOTE</b>	Gives bits and pieces of additional information related to the current topic.
<b>WARNING</b>	Alerts you to any damage that might result from doing or not doing specific actions.
<b>CAUTION</b>	Gives precautionary measures to avoid possible hardware or software problems.
<b>IMPORTANT</b>	Reminds you to do specific actions relevant to the accomplishment of procedures.



---

## Preface

Before using this information and the product it supports, please read the following general information.

1. This Service Guide provides you with all technical information relating to the BASIC CONFIGURATION decided for Acer's "global" product offering. To better fit local market requirements and enhance product competitiveness, your regional office MAY have decided to extend the functionality of a machine (e.g. add-on card, modem, or extra memory capability). These LOCALIZED FEATURES will NOT be covered in this generic service guide. In such cases, please contact your regional offices or the responsible personnel/channel to provide you with further technical details.
2. Please note WHEN ORDERING FRU PARTS, that you should check the most up-to-date information available on your regional web or channel. If, for whatever reason, a part number change is made, it will not be noted in the printed Service Guide. For ACER-AUTHORIZED SERVICE PROVIDERS, your Acer office may have a DIFFERENT part number code to those given in the FRU list of this printed Service Guide. You MUST use the list provided by your regional Acer office to order FRU parts for repair and service of customer machines.



<b>System Specifications</b>	<b>1</b>
Features	1
System Block Diagram	4
Your Acer Notebook tour	5
Front View	5
Closed Front View	6
Left View	7
Right View	8
Rear Panel	8
Bottom Panel	9
Indicators	10
Easy-Launch Buttons	10
Touchpad Basics	11
Using the Keyboard	14
Lock Keys and embedded numeric keypad	14
Windows Keys	15
Hot Keys	16
Special Key	17
Acer Empowering Technology	18
Empowering Technology password	18
Acer eNet Management	18
Acer ePower Management	20
Acer ePresentation Management	21
Acer eDataSecurity Management	22
Acer eLock Management	23
Acer eRecovery Management	24
Acer eSettings Management	25
Windows Mobility Center	26
Using the System Utilities	27
Acer Bio-Protection (for selected models)	27
NTI Shadow	27
Acer GridVista (dual-display compatible)	28
Launch Manager	29
Norton Internet Security	29
Hardware Specifications and Configurations	31
<b>System Utilities</b>	<b>41</b>
BIOS Setup Utility	41
Navigating the BIOS Utility	42
Information	43
Main	44
Advanced	46
Security	47
Boot	51
Exit	52
BIOS Flash Utility	53
Remove HDD/BIOS Utility	54
<b>Machine Disassembly and Replacement</b>	<b>59</b>
Disassembly Requirements	59
General Information	60
Pre-disassembly Instructions	60
Disassembly Process	60
External Module Disassembly Process	61

# Table of Contents

External Modules Disassembly Flowchart	61
Removing the Battery Pack	62
Removing the SD dummy card	63
Removing the PC and ExpressCard dummy cards	63
Removing the Lower Cover	64
Removing the Secondary HDD Cover	65
Removing the Secondary HDD Bracket and Connector	66
Removing the DIMM	68
Removing the WLAN Board Modules	68
Removing the Hard Disk Drive Module	69
Removing the Optical Drive Module	70
Main Unit Disassembly Process	73
Main Unit Disassembly Flowchart	73
Removing the Modem Board	73
Removing the Heatsink Fan Module	74
Removing the CPU and VGA Heatsink Module	75
Removing the CPU	76
Removing the VGA board (for Discrete model only)	77
Removing the Middle Cover and the Power Board	78
Removing the Keyboard	79
Removing the LCD Module	81
Separating the Upper Case from the Lower Case	83
Removing the Launch Board	85
Removing the Touch Pad Board Module	86
Removing the Main Board	89
Removing the ODD Board Module	91
Removing the Speaker Modules	92
Removing the USB Board	93
LCD Module Disassembly Process	95
LCD Module Disassembly Flowchart	95
Main Screw List	95
Removing the LCD Bezel	96
Removing the LCD module with the Brackets	97
Removing the Inverter Board and FPC Cable	98
Removing the LCD Brackets	99
Removing the Left and Right Hinge	100
Removing the Antennas	100
Removing the Internal Microphone and Web Camera	101

## Troubleshooting

**103**

System Check Procedures	104
External Diskette Drive Check	104
External CD-ROM Drive Check	104
Keyboard or Auxiliary Input Device Check	104
Memory check	105
Power System Check	105
Touchpad Check	107
Power-On Self-Test (POST) Error Message	108
Index of Error Messages	109
Phoenix BIOS Beep Codes	112
Index of Symptom-to-FRU Error Message	117
Intermittent Problems	121
Undetermined Problems	122

# Table of Contents

<b>Jumper and Connector Locations</b>	<b>123</b>
Top View .....	123
Bottom View .....	124
<b>FRU (Field Replaceable Unit) List</b>	<b>129</b>
TravelMate 7520/7520G/7220/7220G Exploded Diagram .....	130
<b>Model Definition and Configuration</b>	<b>140</b>
TravelMate 7520/7520G/7220/7220G Series .....	140
<b>Test Compatible Components</b>	<b>163</b>
Microsoft® Windows® Vista Environment Test .....	164
<b>Online Support Information</b>	<b>167</b>
<b>Index</b>	<b>169</b>

# ***Table of Contents***

# System Specifications

---

## Features

Below is a brief summary of the computer's many feature:

### Platform and memory

- ❑ AMD Turion™ 64 X2 dual-core mobile technology TL-66/TL-64/TL-60/TL-56/TL-52 (1 MB L2 cache, 2.3/2.2/2.0/1.8/1.6 GHz, 1600 MHz HyperTransport™ Bus) (for selected models)
- ❑ Mobile AMD Sempron™ 3400+ (512 KB L2 cache, 1.8 GHz, 1600 MHz HyperTransport™ Bus) / 3500+ (512 KB L2 cache, 1.8 GHz, 1600 MHz HyperTransport™ Bus) / 3600+ (256 KB L2 cache, 2.0 GHz, 1600 MHz HyperTransport™ Bus) (for selected models)
- ❑ AMD M690G / ATI SB600
- ❑ Acer InViLink™ 802.11b/g Wi-Fi CERTIFIED® solution, supporting Acer SignalUp™ wireless technology (for selected models)
- ❑ Acer InViLink™ 802.11a/b/g/Draft-N Wi-Fi CERTIFIED® solution, supporting Acer SignalUp™ with Nplify™ wireless technology (for selected models)

### Display and graphics

- ❑ 17" WXGA TFT LCD, 1280 x 800 pixel resolution, supporting simultaneous multi-window viewing via Acer GridVista™
- ❑ ATI Radeon® X1250 integrated 3D graphics, with up to 896 MB of HyperMemory™ (256 MB of dedicated system memory, up to 640 MB of shared system memory), supporting Microsoft® DirectX® 9 and PCI Express® (for selected models)
- ❑ ATI Mobility™ Radeon® X2500 with up to 1024 MB of HyperMemory™ (256 MB of dedicated GDDR2 VRAM, 768 MB of shared system memory), supporting Microsoft® DirectX® 9 and PCI Express® (for selected models)
- ❑ ATI Mobility™ Radeon® HD 2400 XT with up to 896 MB of HyperMemory™ (128 MB of dedicated GDDR2 VRAM, up to 768 MB of shared system memory), supporting Microsoft® DirectX® 9, DirectX® 10 and PCI Express® (for selected models)
- ❑ ATI Mobility™ Radeon® HD 2600 with up to 1024 MB of HyperMemory™ (256 MB of dedicated GDDR2 VRAM, up to 768 MB of shared system memory), supporting Microsoft® DirectX® 9, DirectX® 10 and PCI Express® (for selected models)
- ❑ Dual independent display support
- ❑ 16.7 million colors
- ❑ MPEG-2/DVD hardware-assisted capability (acceleration/full decode) (for selected models)
- ❑ WMV9 (VC-1) and H.264 (AVC) support (acceleration/full decode) (for selected models)
- ❑ S-video/TV-out (NTSC/PAL) support
- ❑ DVI-D (true digital video interface) support

### Storage subsystem

- ❑ 80/120/160 GB or larger hard disk drive with enhanced Acer DASP (Disk Anti-Shock Protection) (for selected models)
- ❑ 80/120/160 GB or larger hard disk drive with Acer DASP (Disk Anti-Shock Protection) (for selected models)

- 
- models)
  - Optical drive options:
    - ▶DVD-Super Multi double-layer drive
    - ▶DVD/CD-RW combo drive
  - 5-in-1 card reader supporting Secure Digital™ (SD), MultiMediaCard (MMC), Memory Stick® (MS), Memory Stick PRO™ (MS PRO), xD-Picture Card™ (xD)

## Input devices

- 105-/106-key keyboard with inverted "T" cursor layout, 2.5 mm (minimum) key travel
- Seamless touchpad pointing device with Acer Bio-Protection fingerprint reader supporting Acer FingerNav 4-way control function (manufacturing option)
- Seamless touchpad pointing device with 4-way scroll button (manufacturing option)
- 12 function keys, four cursor keys, two Windows® keys, hotkey controls, embedded numeric keypad, international language support, independent Euro and US dollar sign keys
- Easy-launch buttons: Acer Empowering Key, Internet, email, user-programmable
- Productivity keys: Lock, Presentation, Sync
- Front-access communication switches: WLAN and Bluetooth®

## Audio

- Two built-in Acer 3DSonic stereo speakers
- Built-in microphone
- MS-Sound compatible

## Communication

- Acer Video Conference featuring:
  - ▶Integrated Acer CrystalEye webcam supporting enhanced Acer PrimaLite™ technology
  - ▶Optional Acer Xpress VoIP phone
- WLAN: Intel® Wireless WiFi Link 4965AGN (dual-band quad-mode 802.11a/b/g/Draft-N) network connection, supporting Acer SignalUp™ with InviLink™ Nplify™ wireless technology (for selected models), or Intel® PRO/Wireless 3945ABG (dual-band tri-mode 802.11a/b/g) Wi-Fi CERTIFIED® network connection, supporting Acer SignalUp™ wireless technology (for selected models), or Acer InviLink 802.11b/g Wi-Fi CERTIFIED® solution, supporting Acer SingalUp™ wireless technology (for selected models)
- WPAN: Bluetooth® 2.0+EDR (Enhanced Data Rate)
- LAN: Gigabit Ethernet; Wake-on-LAN ready
- Modem: 56K ITU V.92 with PTT approval; Wake-on-Ring ready

## I/O Ports

- ExpressCard™/54 slot
- PC Card slot (one Type II)
- 5-in-1 card reader (MS/MS PRO/MMC/SD/xD)
- Four USB 2.0 ports
- DVI-D port (for selected models)
- IEEE 1394 port
- Fast Infrared (FIR) port (for selected models)
- External display (VGA) port
- S-video/TV-out (NTSC/PAL) port



- 
- Headphones/speaker/line-out jack
  - Line-in jack
  - Microphone jack
  - Ethernet (RJ-45) port
  - Modem (RJ-11) port
  - DC-in jack for AC adaptor

## Environment

- Temperature:
  - Operating: 5 °C to 35 °C
  - Non-operating: -20 °C to 65 °C
- Humidity (non-condensing):
  - Operating: 20% to 80%
  - Non-operating: 20% to 80%

# Pomona/TeXcoco Block Diagram

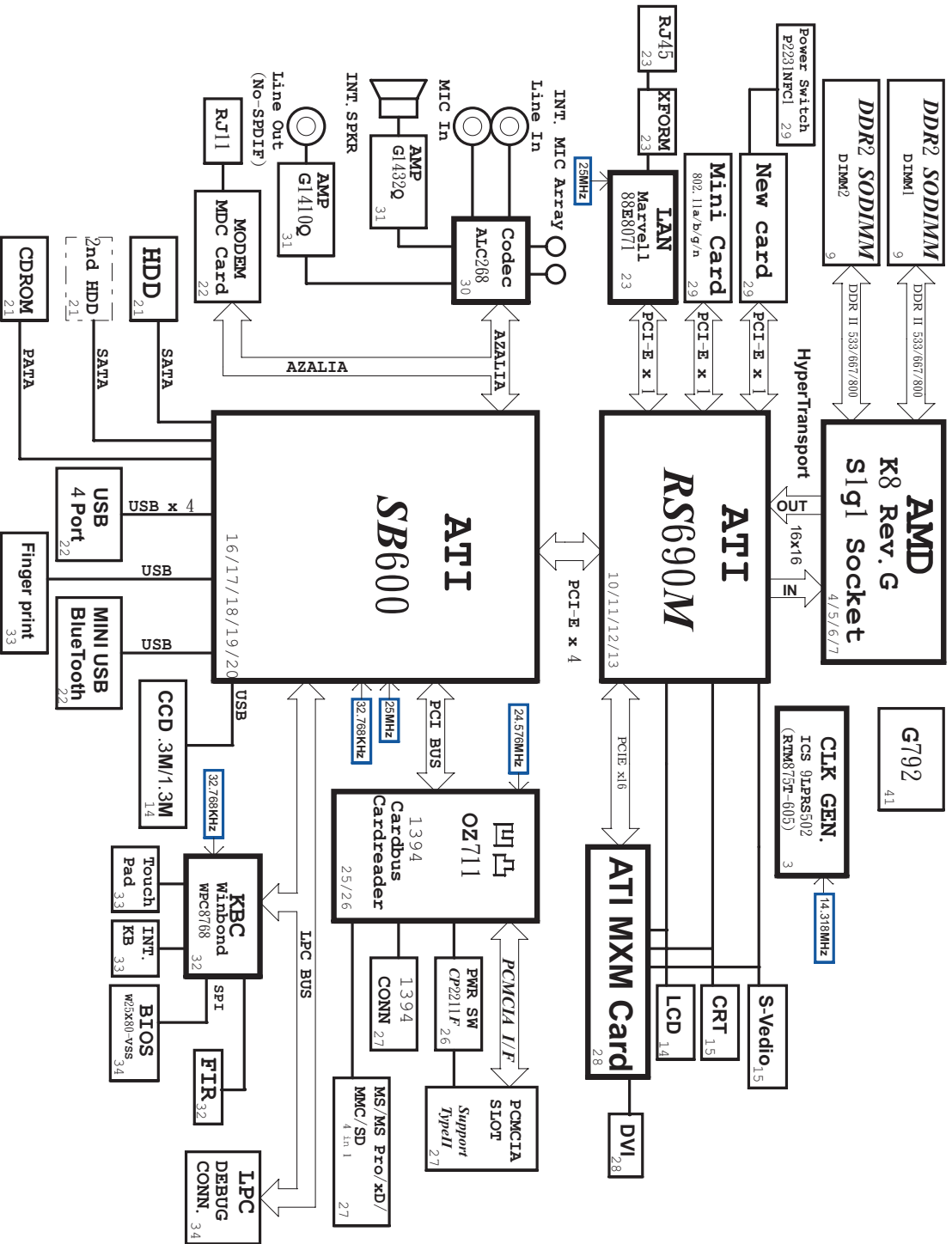

# Your Acer Notebook tour

After knowing your computer features, let us show you around your new TravelMate computer.

## Front View

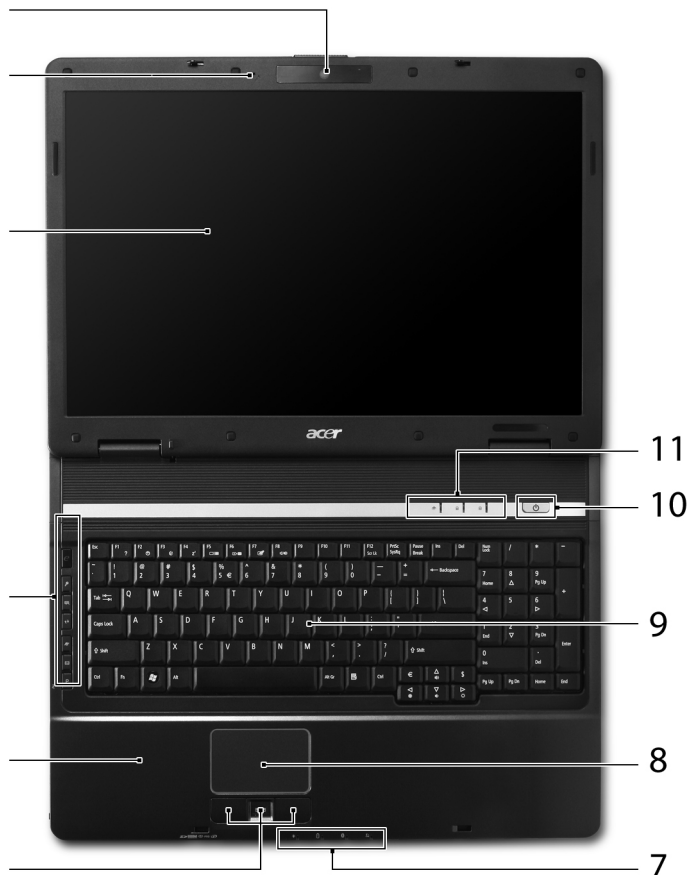





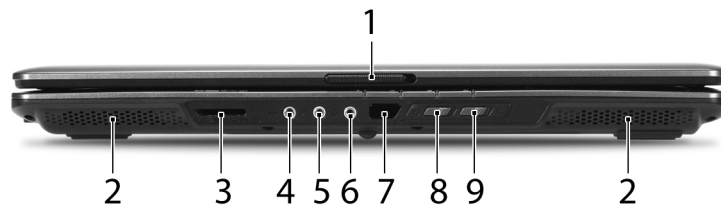

	Icon	Item	Description
1		Acer CrystalEye	0.3 megapixel web camera for video communication.
2		Microphone	Internal microphone for sound recording.
3		Display screen	Also called Liquid-Crystal Display (LCD), displays computer output.
4		Easy-launch buttons	Buttons for launching frequently used programs.
5		Palmrest	Comfortable support area for your hands when you use the computer.

	Icon	Item	Description
6		Click buttons (left, center* and right)	The left and right buttons function like the left and right mouse buttons. *The center button serves as Acer BioProtect fingerprint reader supporting Acer FingerNav 4-way control function (manufacturing option) or a 4-way scroll button (manufacturing option).
7		Status indicators	Light-Emitting Diodes (LEDs) that light up to show the status of the computer's functions and components.
8		Touchpad	Touch-sensitive pointing device which functions like a computer mouse.
9		Keyboard	For entering data into your computer.
10		Power button	Turns the computer on and off.
11		Status indicators	Light-Emitting Diodes (LEDs) that light up to show the status of the computer's functions and components.

## Closed Front View







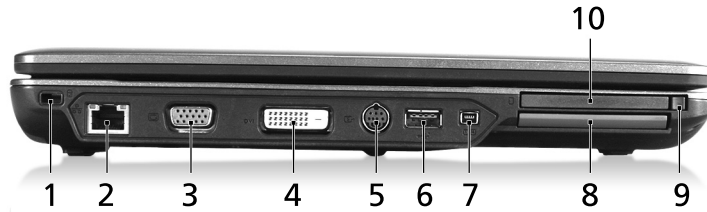

	Icon	Item	Description
1		Latch	Locks and releases the lid.
2		Speakers	Left and right speakers deliver stereo audio output.
3		5-in-1 card reader	Accepts Secure Digital (SD), MultiMediaCard (MMC), Memory Stick (MS), Memory Stick Pro (MS PRO), and xD-Picture Card. <b>Note:</b> Only one card can operate at any given time.
4		Line-in jack	Accepts audio line-in devices (e.g., audio CD player, stereo walkman, mp3 player)
5		Microphone jack	Accepts inputs from external microphones.
6		Headphones/speaker/line-out jack	Connects to audio line-out devices (e.g., speakers, headphones).
7		Infrared port	Interfaces with infrared devices (e.g., infrared printer and IR-aware computer).
8		Bluetooth communication switch	Enable/disable the Bluetooth function. Indicates the status of Bluetooth communication (manufacturing option).

	Icon	Item	Description
9		Wireless communication switch	Enable/disable the wireless function. Indicates the status of wireless LAN communication (manufacturing option).

## Left View



#	Icon	Item	Description
1		Kensington lock slot	Connects to a Kensington-compatible computer security lock.
2		Ethernet (RJ-45) port	Connects to an Ethernet 10/100/1000-based network.
3	DVI-D	DVI-D port	Supports digital video connections.
4		External display (VGA) port	Connects to a display device (e.g., external monitor, LCD projector).
5		S-Video/TV-out (NTSC/PAL) port	Connects to a television or display device with S-video input.
6		USB 2.0 port	Connects to USB 2.0 devices (e.g., USB mouse, USB camera).
7		IEEE 1394 port	Connects to IEEE 1394 devices.
8	EXPRESS CARD	ExpressCard/54 slot	Accepts one ExpressCard/54 module.
9		PC Card slot eject button	Ejects the PC Card from the slot.
10		PC Card slot	Accepts one Type II PC Card.



## Right View



	Icon	Item	Description
1		Optical drive	Internal optical drive; accepts CDs or DVDs
2		Optical disk access indicator	Lights up when the optical drive is active.
3		Optical drive eject button	Ejects the optical disk from the drive.
4		Emergency eject hole	Ejects the optical drive tray when the computer is turned off.

## Rear Panel



#	Icon	Item	Description
1		Three USB 2.0 ports	Connect to USB 2.0 devices (e.g., USB mouse, USB camera).
2		Modem (RJ-11) port	Connects to a phone line.
3		DC-in jack	Connects to an AC adapter.
4		Ventilation slots	Enable the computer to stay cool, even after prolonged use.

# Bottom Panel

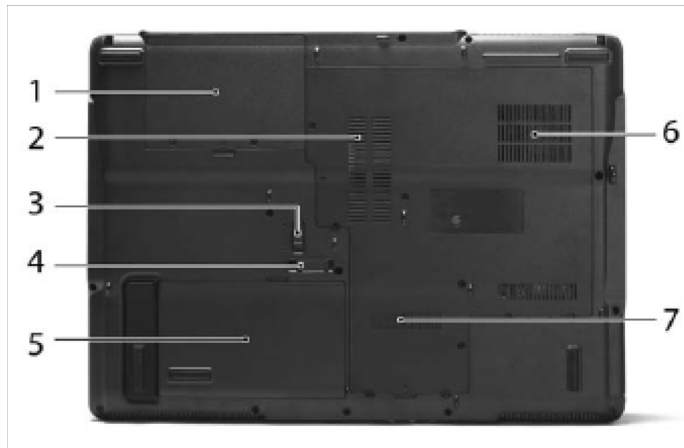







Icon	Item	Description
1	Second Hard disk bay	Houses the computer's optional second hard disk. (Secured with a screw).
2	Memory compartment	Houses the computer's main memory.
3	Battery lock	Locks the battery in position.
4	Battery release latch	Releases the battery to remove the battery pack.
5	Battery bay	Houses the computer's battery pack.
6	Ventilation slots	Enable the computer to stay cool, even after prolonged use.
7	Hard disk bay	Houses the computer's hard disk (secured with screws)

# Indicators

The computer has several easy-to-read status indicators:



The front panel indicators are visible even when the computer cover is closed.

Icon	Function	Description
	Power	Indicates the computer's power status.
	Battery	Indicates the computer's battery status.
	Bluetooth	Indicates the status of Bluetooth communication.
	Wireless LAN	Indicates the status of wireless LAN communication.
	HDD	Indicates when the hard disk drive is active.
	Num Lock	Lights up when Num Lock is activated.
	Caps Lock	Lights up when Caps Lock is activated.

**NOTE:** 1. **Charging:** The light shows amber when the battery is charging. 2. **Fully charged:** The light shows green when in AC mode.

## Easy-Launch Buttons

There are several conveniently located easy-launch buttons. They are: mail Web browser, Empowering Key “e” and one user-programmable button.

Press “e” to run the Acer Empowering Technology. The mail and Web browser buttons are pre-set to email and Internet programs, but can be reset by users. To set the Web browser, mail and programmable buttons, run the Acer Launch Manager.





Launch key	Default application
e	Acer Empowering Technology (user-programmable)
	Email application (user-programmable)



Launch key	Default application
	Internet browser (user-programmable)
P	User-programmable

Three productivity keys give users one-touch access to protection and manageability features for a more secure, smarter and easier way to work.

- Lock key - runs the Windows® lock function to lock the notebook when you step out. If the laptop is equipped with Acer BioProtect, you only need to swipe your finger to log into Windows® again.
- Presentation key - minimizes open application windows and prepares the display for impressive presentations.
- Sync key - instantly synchronizes your computer system to an external storage device, for convenient and secure backup.

Icon	Productivity key	Default application
	Lock	Launch Windows Lock function
	Presentation	Minimizes your open windows and prepares your display for presenting
	Sync	Launch NTI Shadow

## Touchpad Basics

The following teaches you how to use the touchpad:

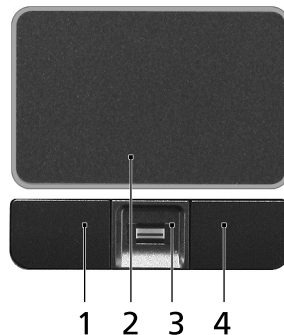

- Move your finger across the touchpad (2) to move the cursor.
- Press the left (1) and right (4) buttons located beneath the touchpad to perform selection and execution functions. These two buttons are similar to the left and right buttons on a mouse. Tapping on the touchpad is the same as clicking the left button.
- Use the 4-way scroll (3) button to scroll up or down and move left or right a page. This button mimics your cursor pressing on the right scroll bar of Windows applications.

Function	Left Button (1)	Right Button (4)	Main touchpad (2)	Center button (3)
Execute	Click twice quickly		Tap twice (at the same speed as double-clicking the mouse button)	
Select	Click once		Tap once	
Drag	Click and hold, then use finger to drag the cursor on the touchpad		Tap twice (at the same speed as double-clicking a mouse button) then hold finger to the touchpad on the second tap to drag the cursor.	
Access context menu		Click once		
Scroll				Click and hold to move up/down/left/right.

**NOTE:** When using the touchpad, keep it - and your fingers - dry and clean. The touchpad is sensitive to finger movement; hence, the lighter the touch, the better the response. Tapping too hard will not increase the touchpad's responsiveness.

**NOTE:** By default, vertical and horizontal scrolling is enabled on your touchpad. It can be disabled under Mouse settings in Windows Control Panel.

# Using the Keyboard

The keyboard has full-sized keys and an embedded numeric keypad, separate cursor, lock, Windows, function and special keys.

## Lock Keys and embedded numeric keypad

The keyboard has three lock keys which you can toggle on and off.

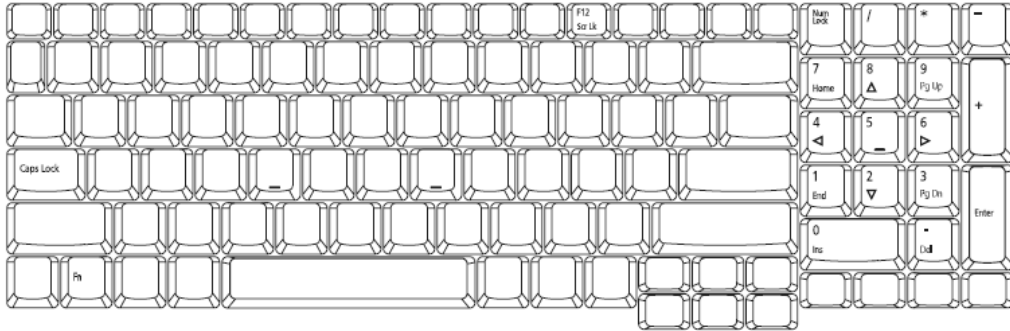





















Lock key	Description
Caps Lock	When Caps Lock is on, all alphabetic characters typed are in uppercase.
Num Lock <Fn> + <F11>	When Num Lock is on, the embedded keypad is in numeric mode. The keys function as a calculator (complete with the arithmetic operators +, -, *, and /). Use this mode when you need to do a lot of numeric data entry. A better solution would be to connect an external keypad.
Scroll Lock <Fn> + <F12>	When Scroll Lock is on, the screen moves one line up or down when you press the up or down arrow keys respectively. Scroll Lock does not work with some applications.

The embedded numeric keypad functions like a desktop numeric keypad. It is indicated by small characters located on the upper right corner of the keycaps. To simplify the keyboard legend, cursor-control key symbols are not printed on the keys.

Desired access	Num Lock on	Num Lock off
Number keys on embedded keypad	Type numbers in a normal manner.	
Cursor-control keys on embedded keypad	Hold <Shift> while using cursor-control keys.	Hold <Fn> while using cursor-control keys.
Main keyboard keys	Hold <Fn> while typing letters on embedded keypad.	Type the letters in a normal manner.

# Windows Keys

The keyboard has two keys that perform Windows-specific functions.

Key	Description	Key
 Windows key	<p>Pressed alone, this key has the same effect as clicking on the Windows Start button; it launches the Start menu.</p> <p>It can also be used with other keys to provide a variety of functions:</p> <p>&lt;  &gt; : Open or close the Start menu</p> <p>&lt;  &gt; + &lt;D&gt;: Display the desktop</p> <p>&lt;  &gt; + &lt;E&gt;: Open Windows Explore</p> <p>&lt;  &gt; + &lt;F&gt;: Search for a file or folder</p> <p>&lt;  &gt; + &lt;G&gt;: Cycle through Sidebar gadgets</p> <p>&lt;  &gt; + &lt;L&gt;: Lock your computer (if you are connected to a network domain), or switch users (if you're not connected to a network domain)</p> <p>&lt;  &gt; + &lt;M&gt;: Minimizes all windows</p> <p>&lt;  &gt; + &lt;R&gt;: Open the Run dialog box</p> <p>&lt;  &gt; + &lt;T&gt;: Cycle through programs on the taskbar</p> <p>&lt;  &gt; + &lt;U&gt;: Open Ease of Access Center</p> <p>&lt;  &gt; + &lt;X&gt;: Open Windows Mobility Center</p> <p>&lt;  &gt; + &lt;BREAK&gt;: Display the System Properties dialog box</p> <p>&lt;  &gt; + &lt;SHIFT+M&gt;: Restore minimized windows to the desktop</p> <p>&lt;  &gt; + &lt;TAB&gt;: Cycle through programs on the taskbar by using Windows Flip 3-D</p> <p>&lt;  &gt; + &lt;SPACEBAR&gt;: Bring all gadgets to the front and select Windows Sidebar</p> <p>&lt;CTRL&gt; + &lt;  &gt; + &lt;F&gt;: Search for computers (if you are on a network)</p> <p>&lt;CTRL&gt; + &lt;  &gt; + &lt;TAB&gt;: Use the arrow keys to cycle through programs on the taskbar by using Windows Flip 3-D</p> <p><b>Note:</b> Depending on your edition of Windows Vista, some shortcuts may not function as described.</p>	 Windows key
 Application key	<p>This key has the same effect as clicking the right mouse button; it opens the application's context menu.</p>	 Application key

# Hot Keys

The computer employs hotkeys or key combinations to access most of the computer's controls like screen brightness, volume output and the BIOS utility.

To activate hot keys, press and hold the <Fn> key before pressing the other key in the hotkey combination.

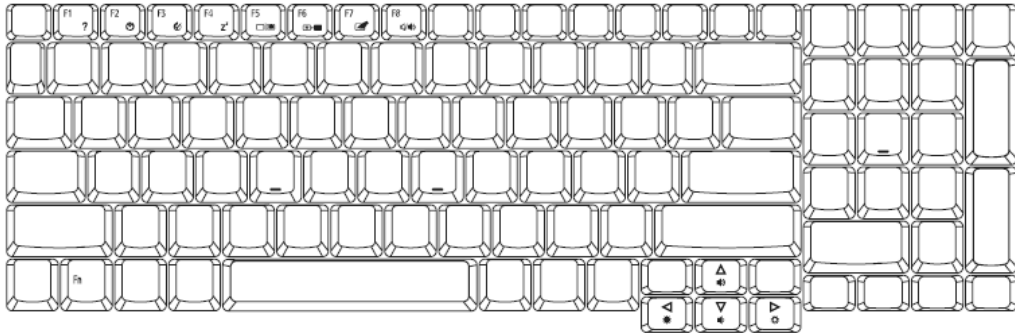

Hotkey	Icon	Function	Description
<Fn> + <F1>	?	Hotkey help	Displays help on hotkeys.
<Fn> + <F2>		Acer eSettings	Launches Acer eSettings in Acer Empowering Technology.
<Fn> + <F3>		Acer ePower Management	Launches Acer ePower Management in Acer Empowering Technology.
<Fn> + <F4>	Zz	Sleep	Puts the computer in Sleep mode.
<Fn> + <F5>		Display toggle	Switches display output between the display screen, external monitor (if connected) and both.
<Fn> + <F6>		Screen blank	Turns the display screen backlight off to save power. Press any key to return.
<Fn> + <F7>		Touchpad toggle	Turns the internal touchpad on and off.
<Fn> + <F8>		Speaker toggle	Turns the speakers on and off.
<Fn> + <↑>		Volume up	Increases the sound volume.
<Fn> + <↓>		Volume down	Decreases the sound volume.
<Fn> + <↔>		Brightness up	Increases the screen brightness.
<Fn> + <↔>		Brightness down	Decreases the screen brightness.

---

## Special Key

You can locate the Euro symbol and the US dollar sign at the upper-center and/or bottom-right of your keyboard.

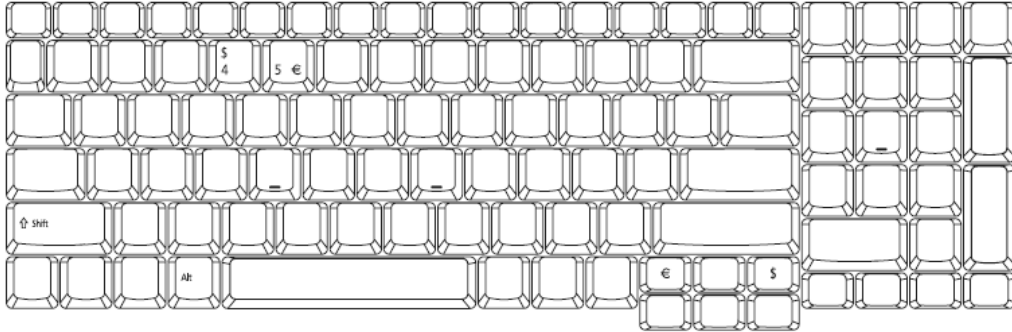

### The Euro symbol

1. Open a text editor or word processor.
2. Either press <€> at the bottom-right of the keyboard, or hold <Alt Gr> and then press the <5> key at the upper-center of the keyboard.

### The US dollar sign

1. Open a text editor or word processor.
2. Either directly press the <\$> key at the bottom-right of the keyboard, or hold <Shift> and then press the <4> key at the upper-center of the keyboard.

**NOTE:** This function varies by the operating system version.

**NOTE:** Some fonts and software do not support the Euro symbol. Please refer to [www.microsoft.com/typography/faq/faq12.htm](http://www.microsoft.com/typography/faq/faq12.htm) for more information.

---

# Acer Empowering Technology

The Empowering Technology toolbar makes it easy for you to access frequently used functions and manage your new Acer system. Displayed by default in the upper half of your screen, it provides access to the following utilities:

- Acer eNet Management** hooks up to location-based networks intelligently.
- Acer ePower Management** optimizes battery usage via customizable power plans.
- Acer ePresentation Management** connects to a projector and adjusts display settings.
- Acer eDataSecurity Management** protects data with passwords and encryption.
- Acer eLock Management** limits access to external storage media.
- Acer eRecovery Management** backs up and recovers data flexibly, reliably and completely.
- Acer eSettings Management** accesses system information and adjusts settings easily.



For more information, right click on the Empowering Technology toolbar, then select the **"Help"** or **"Tutorial"** function.

## Empowering Technology password

Before using Acer eLock Management and Acer eRecovery Management, you must initialize the Empowering Technology password. Right-click on the Empowering Technology toolbar and select **"Password Setup"** to do so. If you have not initialized the Empowering Technology password and run Acer eLock Management or Acer eRecovery Management, you will be asked to create it.

**NOTE:** If you lose the Empowering Technology password, there is no way to reset it except by reformatting your system. Make sure to remember or write down your password!

## Acer eNet Management

Acer eNet Management helps you quickly connect to both wired and wireless networks in a variety of locations. To access this utility, select **"Acer eNet Management"** from the Empowering Technology toolbar or run the program from the Acer Empowering Technology program group in Start menu. You can also set Acer eNet Management to start automatically when you boot up your PC.

Acer eNet Management automatically detects the best settings for a new location, while offering you the option to manually adjust the settings to match your needs.

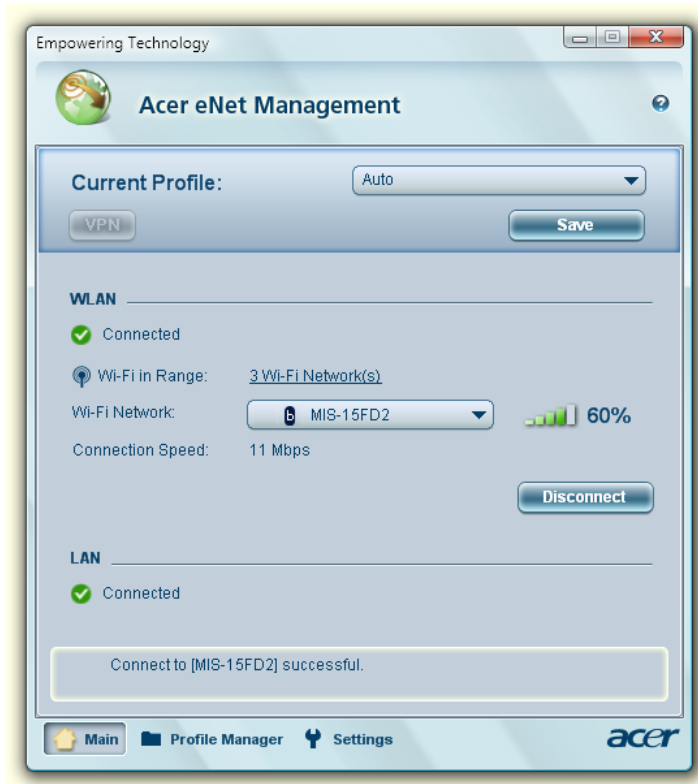

Acer eNet Management can save network settings for a location to a profile, and automatically switch to the appropriate profile when you move from one location to another. Settings stored include network connection settings (IP and DNS settings, wireless AP details, etc.), as well as default printer settings. Security and safety concerns mean that Acer eNet Management does not store username and password information.



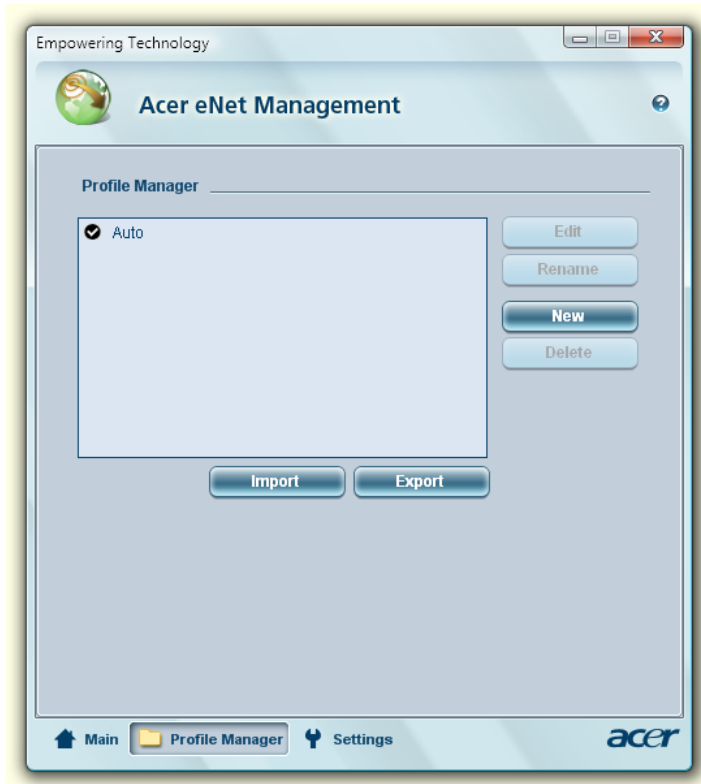

## Acer ePower Management

Acer ePower Management features a straightforward user interface for configuring your power management options. To access this utility, select **"Acer ePower Management"** from the Empowering Technology toolbar, run the program from the Acer Empowering Technology program group in Start menu, or right-click the Windows power icon in the system tray and select **"Acer ePower Management"**.

### Using power plans

Acer ePower Management comes with three predefined power plans: Balanced, High performance and Power saver. You can also create customized power plans. You can create, switch between, edit, delete and restore power plans, as described below.

View and adjust settings for On Battery and Plugged In modes by clicking the appropriate tabs. You can open Windows power options by clicking **"More Power Options"**.

**NOTE:** You cannot delete the predefined power plans.

### To create a new power plan:

Creating customized power plans allows you to save and quickly switch to a personalized set of power options.

1. Click the Create Power Plan icon. 
2. Enter a name for your new power plan.
3. Choose a predefined power plan to base your customized plan on.
4. If necessary, change the display and sleep settings you want your computer to use.
5. Click **"OK"** to save your new power plan.

### To switch between power plans:

1. Select the power plan you wish to switch to from the drop-down list.
2. Click **"Apply"**.

### To edit a power plan:

Editing a power plan allows you to adjust system settings like LCD brightness and CPU speed. You can also turn on/off system components to extend battery life.

1. Switch to the power plan you wish to edit
2. Adjust settings as required.
3. Click **"Apply"** to save your new settings.

### To delete a power plan:

You cannot delete the power plan you are currently using. If you want to delete the active power plan, switch to another one first.

1. Select the power plan you wish to delete from the drop-down list.
2. Click the Delete Power Plan icon. 

### Battery status

For real-time battery life estimates based on current usage, refer to the panel in the upper half of the window.

Click the  to view estimated battery life in sleep and hibernate modes.



## Acer ePresentation Management

Acer ePresentation Management lets you project your computer's display to an external display device or projector using the hotkey: **<Fn> + <F5>**. If auto-detection hardware is implemented in the system and the external display supports it, your system display will be automatically switched out when an external display is

connected to the system. For projectors and external devices that are not auto-detected, launch Acer ePresentation Management to choose an appropriate display setting.



**NOTE:** If the restored resolution is not correct after disconnecting a projector, or you need to use an external resolution that is not supported by Acer ePresentation Management, adjust your display settings using Display Properties or the utility provided by the graphics vendor.

## Acer eDataSecurity Management

Acer eDataSecurity Management is an encryption utility that protects your files from being accessed by unauthorized persons. It is conveniently integrated with Windows Explorer as a shell extension for quick data encryption/decryption and also supports on-the-fly file encryption for Lotus Notes and Microsoft Outlook.

The Acer eDataSecurity Management setup wizard will prompt you for a supervisor password and default encryption password. This password will be used to encrypt files by default, or you can choose to enter your own password when encrypting a file.



**NOTE:** The password used to encrypt a file is the unique key that the system needs to decrypt it. If you lose the password, the supervisor password is the only other key capable of decrypting the file. If you lose both passwords, there will be no way to decrypt your encrypted file! **Be sure to safeguard all related passwords!**

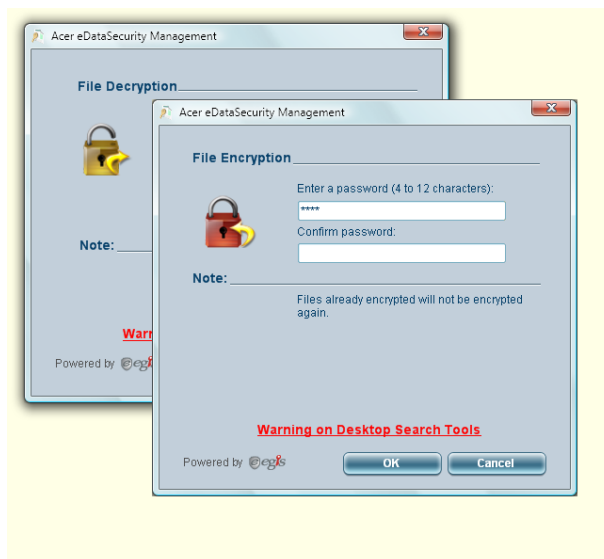

## Acer eLock Management

Acer eLock Management is simple yet effective utility that allows you to lock removable storage, optical and floppy drive devices to ensure that data can't be stolen while your system is unattended.

- Removable Storage Devices — includes USB disk drives, USB pen drives, USB flash drives, USB MP3 drives, USB memory card readers, IEEE 1394 disk drives, and any other removable storage devices that can be mounted as a file system when plugged into the system.
- Optical Drive Devices — includes any kind of CD-ROM, DVD-ROM, HD-DVD or Blu-ray drive devices.
- Floppy Drive Devices — 3.5-inch floppy drives only.

To use Acer eLock Management, the Empowering Technology password must be set first. Once set, you can apply locks to any of the devices types. Lock(s) will immediately be set without any reboot necessary, and will remain after rebooting, until removed.

**NOTE:** If you lose the Empowering Technology password, there is no method to reset it except by reformatting your system. Make sure to remember or write down your password.

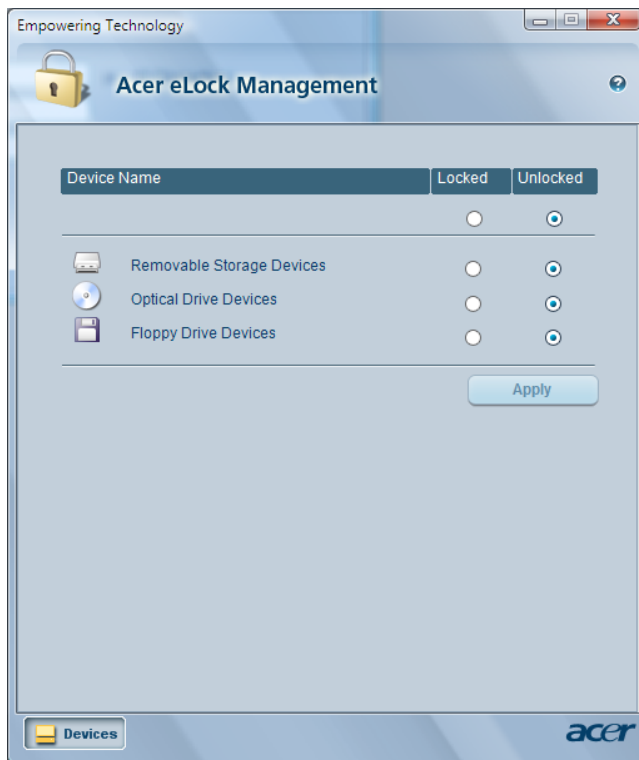

## Acer eRecovery Management

Acer eRecovery Management is a versatile backup utility. It allows you to create full or incremental backups, burn the factory default image to optical disc, and restore from previously created backups or reinstall applications and drivers. By default, user-created backups are stored to the D:\ drive.

Acer eRecovery Management provides you with:

- Password protection (Empowering Technology password)
- Full and incremental backups to hard disk or optical disc
- Creation of backups:
  - ✦ Factory default image
  - ✦ User backup image
  - ✦ Current system configuration
  - ✦ Application backup
- Restore and recovery:
  - ✦ Factory default image
  - ✦ User backup image
  - ✦ From previously-created CD/DVD
  - ✦ Reinstall applications/drivers

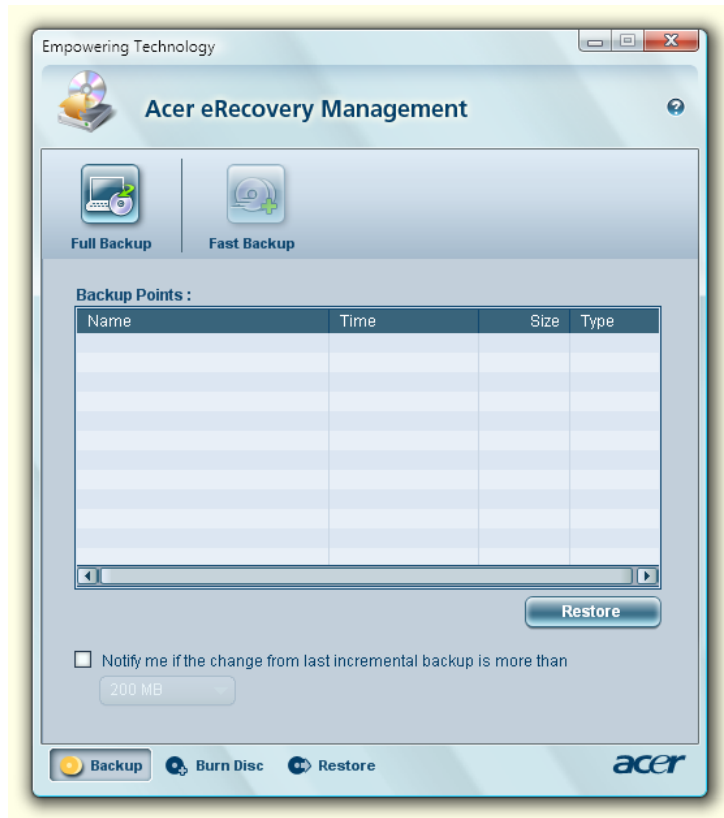

For more information, please refer to "**Acer eRecovery Management**" on page 61 in the **AcerSystem User's Guide**.

**NOTE:** If your computer did not come with a Recovery CD or System CD, please use Acer eRecovery Management's "System backup to optical disc" feature to burn a backup image to CD or DVD. To ensure the best results when recovering your system using a CD or Acer eRecovery Management, detach all peripherals (except the external Acer ODD, if your computer has one), including your Acer ezDock.

## Acer eSettings Management

Acer eSettings Management allows you to inspect hardware specifications, set BIOS passwords and modify boot options.

Acer eSettings Management also:

- Provides a simple graphical user interface for navigation.
- Prints and saves hardware specifications.

- ❑ Lets you set an asset tag for your system.

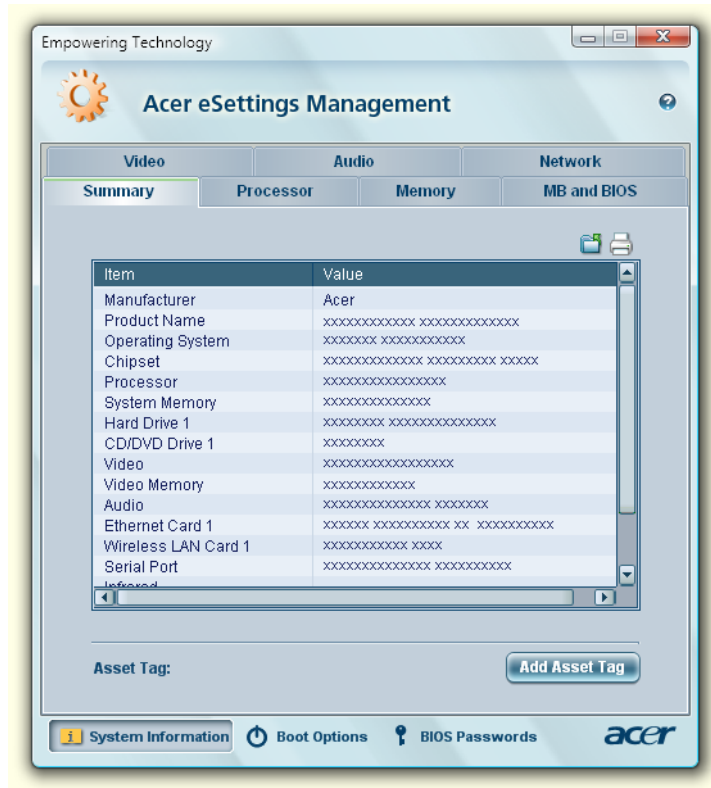

## Windows Mobility Center

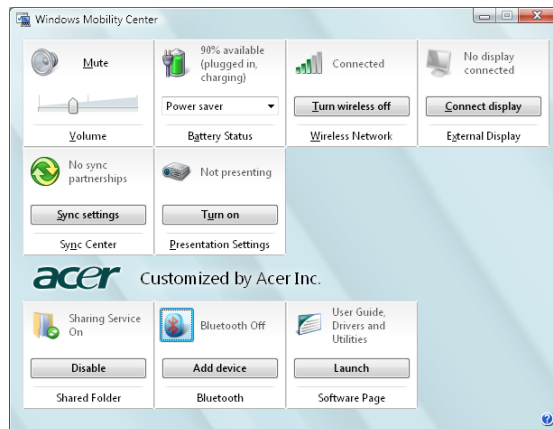

The Windows Mobility Center collects key mobile-related system settings in one easy-to-find place, so you can quickly configure your Acer system to fit the situation as you change locations, networks or activities. Settings include display brightness, power plan, volume, wireless networking on/off, external display settings, display orientation and synchronization status.

Windows Mobility Center also includes Acer-specific settings like Bluetooth Add Device (if applicable), sharing folders overview/sharing service on or off, and a shortcut to the Acer user guide, drivers and utilities.

To launch Windows Mobility Center:

- ❑ Use the shortcut key <Windows> + <X>
- ❑ Start Windows Mobility Center from the Control panel
- ❑ Start Windows Mobility Center from the Accessories program group in the Start menu.

---

# Using the System Utilities

## Acer Bio-Protection (for selected models)

Acer Bio-Protection Fingerprint Solution is a multi-purpose fingerprint software package integrated with the Microsoft® Windows® operating system. Utilizing the uniqueness of one's fingerprint features, Acer Bio-Protection Fingerprint Solution has incorporated protection against unauthorized access to your computer with Pre-Boot Authentication (PBA), centralized password management with Password Bank, and fast application/website launching and login with Acer FingerLaunch.

Acer Bio-Protection Fingerprint Solution also allows you to navigate through web browsers and documents using Acer FingerNav. With Acer Bio-Protection Fingerprint Solution, you can now enjoy an extra layer of protection for your personal computer, as well as the convenience of accessing your daily tasks with a simple swipe of your finger!

For more information refer to the Acer Bio-Protection help files.



## NTI Shadow

NTI Shadow allows users to schedule continuous backup jobs that copy the contents of one or more folders (the "backup source") to another location (the "backup destination"). The backup jobs are continuous because they are scheduled to regularly update the data in the backup folder either continuously or in user-defined intervals. You can schedule a job to run every certain number of minutes, on certain days at a specified time, or whenever any data in the backup source are modified.

Shadow can also be configured to archive file versions. If this option is enabled, then any file that is saved or overwritten will trigger Shadow to archive the previous version of the file. The file versions are stored in a Revisions folder in the backup destination. Users can configure how many versions of a file to maintain.

Shadow supports backups on local hard drives, USB/FireWire external hard drives, USB pen drives, NAS devices, and any drive with drive letter access.

Launching the utility is as easy as pressing one buttons. For more information refer to the NTI Shadow help files.



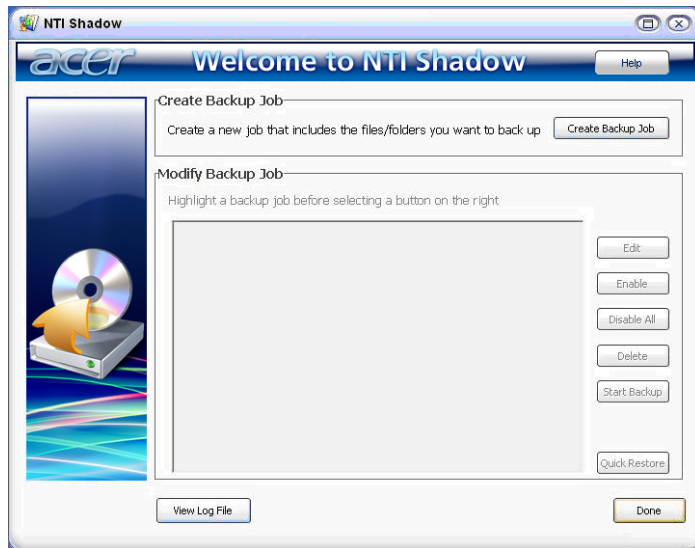

## Acer GridVista (dual-display compatible)

**NOTE:** This feature is only available on certain models.

To enable the dual monitor feature of the notebook, first ensure that the second monitor is connected, then select **Start, Control Panel, Display** and click on **Settings**. Select the secondary monitor (2) icon in the display box and then click the check box **Extend my windows desktop onto this monitor**. Finally, click **Apply** to confirm the new settings and click **OK** to complete the process.

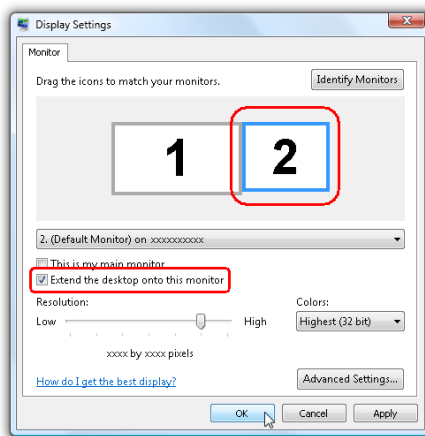

Acer GridVista is a handy utility that offers four pre-defined display settings so you can view multiple windows on the same screen. To access this function, please go to **Start>All Programs** and click on **Acer GridVista**. You may choose any one of the four display settings indicated below:



Double (vertical), Triple (primary at left), Triple (primary at right), or Quad Acer GridVista is dual-display compatible, allowing two displays to be partitioned independently.

Acer GridVista is dual-display compatible, allowing two displays to be partitioned independently.

AcerGridVista is simple to set up:

1. Run Acer GridVista and select your preferred screen configuration for each display from the task bar.
2. Drag and drop each window into the appropriate grid.
3. Enjoy the convenience of a well-organized desktop.

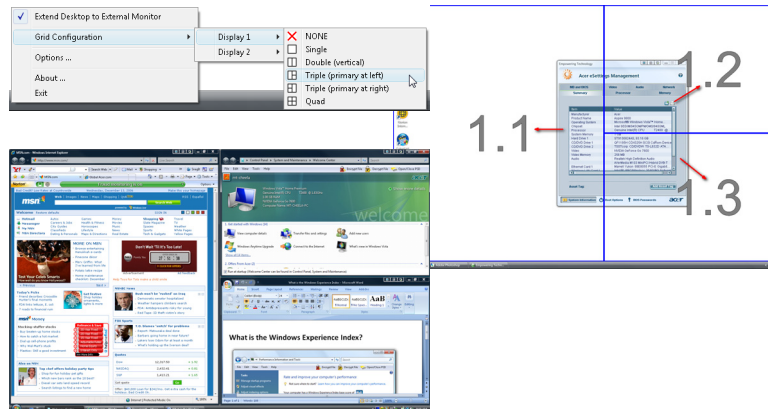

**NOTE:** Please ensure that the resolution setting of the second monitor is set to the manufacturer's recommended value.

## Launch Manager

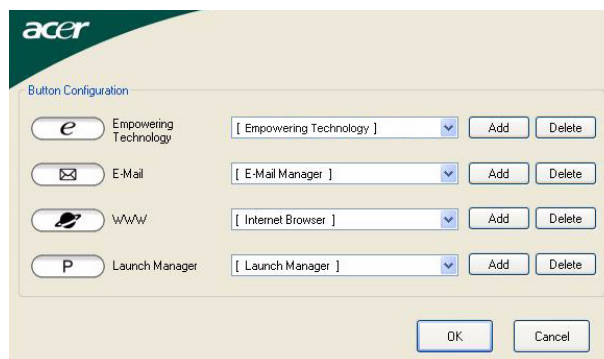

Launch Manager allows you to set the four easy-launch buttons located above the keyboard. You can access the Launch Manager by clicking on Start > All Programs > Launch Manager to start the application.

## Norton Internet Security

Norton Internet Security is an anti-virus utility that can protect against viruses, keeping your data safe and secure.

### How do I check for viruses?

1. Double-click the **Norton Internet Security** icon on the Windows desktop.
2. Select **Tasks & Scans**.

3. Select **Run Scan** to scan your system.

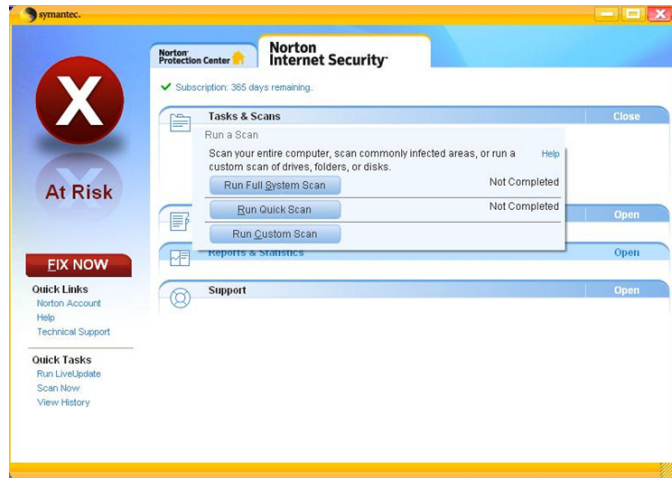

4. When the scan is complete, review the results of the scan.

**NOTE:** For optimal security, run a Full System Scan when scanning your computer for the first time.

You can schedule customized virus scans that run unattended on specific dates and times or at periodic intervals. If you are using the computer when the scheduled scan begins, it runs in the background so that you do not have to stop working.

For more information refer to the Norton Internet Security help files.

# Hardware Specifications and Configurations

## Processor

Item	Specification
CPU type	AMD Turion™ 64 X2 dual-core mobile technology TL-66/TL-64/TL-60/TL-56/TL-52 (1 MB L2 cache, 2.3/2.2/2.0/1.8/1.6 GHz, 1600 MHz HyperTransport™ Bus) Mobile AMD Sempron™ 3400+ (512 KB L2 cache, 1.8 GHz, 1600 MHz HyperTransport™ Bus) / 3500+ (512 KB L2 cache, 1.8 GHz, 1600 MHz HyperTransport™ Bus) / 3600+ (256 KB L2 cache, 2.0 GHz, 1600 MHz HyperTransport™ Bus)
Core logic	AMD M690G / ATI SB600
CPU package	Socket M (FCPGA6)
CPU core voltage	1.0375V to 1.3V

## CPU Fan True Value Table

DTS(degree C)	Fan Speed (rpm)	Acoustic Level (dBA)
45-50	0-3000	29
55-66	0-3300	33
68-74	3300-3800	38
78-83	3800-4100	40
86-91	4100-4800	40

Throttling 50%: On= 99 ° C; OFF=93 ° C

OS shut down at 105 ° C; H/W shot down at 110 ° .C

## BIOS

Item	Specification
BIOS vendor	Phoenix
BIOS Version	1.02 (MP version)
BIOS ROM type	SST/AMD 1MB CMOS Boot Block Flash Memory
BIOS ROM size	1M byte FLASH ROM SST
BIOS package	10-lead TSOP (10mmx20mm)
Supported protocols	ACPI 1.0b/2.0/3.0 compliance, PCI 2.2, System/HDD Password Security Control, INT 13H Extensions, PnP BIOS 1.0a SMBIOS 2.4, BIOS Boot Specification, Simple Boot Flag 1.0, Boot Block, PCI Bus Power Management Interface Specification, USB Specification 1.1/2.0, IEEE 1394 1.0, USB/1394 CD-ROM Boot Up support, PC Card Standard 1995 (PCMCIA 3.0 Compliant Device), IrDA 1.0, Intel AC97 CNR Specification, WfM 2.0, PXE 2.1, Boot Integrity Service Application Program Interface (BIS) 1.0, PC99a and Mobile PC2001 Compliant
BIOS password control	Set by setup manual

Item	Specification
Cache controller	Built-in CPU
Cache size	512 KB to 1MB (See CPU type)

## System Memory

Item	Specification
Memory controller	Built-in
Memory size	0MB (no on-board memory)
DIMM socket number	2 sockets
Supports memory size per socket	2048MB
Supports maximum memory size	4G for 64bit OS(with two 2GB SODIMM)
Supports DIMM type	DDR 2 Synchronous DRAM
Supports DIMM Speed	533/677 MHz
Supports DIMM voltage	1.8V and 0.9V
Supports DIMM package	200-pin soDIMM
Memory module combinations	You can install memory modules in any combinations as long as they match the above specifications.

## Memory Combinations

Slot 1	Slot 2	Total Memory
0MB	256MB	256MB
0MB	512MB	512MB
0MB	1024MB	1024MB
0MB	2048MB	2048MB
256MB	256MB	512MB
256MB	512MB	768MB
256MB	1024MB	1280MB
256MB	2048MB	2304MB
512MB	256MB	768MB
512MB	512MB	1024MB
512MB	1024MB	1536MB
512MB	2048MB	2560MB
1024MB	0MB	1024MB
1024MB	256MB	1280MB
1024MB	512MB	1536MB
1024MB	1024MB	2048MB
1024MB	2048MB	3072MB
2048MB	0MB	2048MB
2048MB	256MB	2304MB
2048MB	512MB	2560MB
2048MB	1024MB	3072MB
2048MB	2048MB	4096MB

**NOTE:** Above table lists some system memory configurations. You may combine DIMMs with various capacities to form other combinations. On above table, the configuration of slot 1 and slot 2 could be reversed.

Item	Specification
LAN Chipset	Broadcom 5787M

Item	Specification
Supports LAN protocol	10/100/1000 Mbps
LAN connector type	RJ45
LAN connector location	Left side
Features	Integrated 10/100 BASE-T transceiver Wake on LAN support compliant with ACPI 2.0 PCI v2.2

### Bluetooth Interface

Item	Specification
Chipset	Foxconn T60H928.01
Data throughput	723 bps (full speed data rate)
Protocol	Bluetooth 1.1 (Upgradeable to Bluetooth 1.2 when SIG specification is ratified).
Interface	USB 1.1
Connector type	USB

### Wireless Module 802.11b/g

Item	Specification
Chipset	Acer InviLink™ 802.11b/g Wi-Fi CERTIFIED® solution, supporting Acer SignalUp™ with InviLink™ Nplify™ wireless technology Acer InviLink™ 802.11a/b/g/Draft-N Wi-Fi CERTIFIED® solution, supporting Acer SignalUp™ wireless technology
Data throughput	11~54 Mbps, up to 270 Mbps for Draft-N
Protocol	802.11b+g, Draft-N
Interface	PCI bus (mini PCI socket for wireless module)

### Hard Disk Drive Interface

Item				
Vendor & Model Name	HGST 2.5" HTS541680J9SA00 SURUGA-B	SEAGATE 2.5" ST9120822AS (9S1133-190) Venus SATA	WD 2.5" WD1600BEVS-22RSTO ML80 SATA	HGST 2.5" HTS541616J9SA00 SURUGA-B
Capacity (MB)	80000	120000	160000	160000
Bytes per sector	512	512	512	512
Data heads	2	3	3	4
Drive Format				
Disks	1	2	2	2
Spindle speed (RPM)	5400 RPM	5400 RPM	5400 RPM	5400 RPM
Performance Specifications				
Buffer size	8MB	8MB	8MB	8MB

### Hard Disk Drive Interface

Item				
Interface	SATA	SATA	SATA	SATA
Max. media transfer rate (disk-buffer, Mbytes/s)	540	540	540	540
Data transfer rate (host~buffer, Mbytes/s)	100 MB/Sec. Ultra DMA mode-5	150 MB/Sec. Ultra DMA mode-5	150 MB/Sec. Ultra DMA mode-5	150 MB/Sec. Ultra DMA mode-5
DC Power Requirements				
Voltage tolerance	5V(DC) +/- 5%	5V(DC) +/- 5%	5V(DC) +/- 5%	5V(DC) +/- 5%

### Combo Drive module

Item	Specification
Vendor & model name	SONY COMBO 12.7mm Tray 24X CRX880A
Performance Specification	With CD Diskette                      With DVD Diskette
Transfer rate (KB/sec)	Sustained: Max 3.6Mbytes/sec                      Sustained: Max 10.8Mbytes/sec
Buffer Memory	2MB
Interface	PATA
Applicable disc format	<p>1. Reads and writes data in each CD-ROM, CD-ROMXA, CD-I FMV, Video CD and CD-EXTRA</p> <p>2. Reads data in Photo CD (Single and multi session)</p> <p>3. Reads and writes standard CD-DA</p> <p>4. Reads and writes CD-R discs conforming to "Orange Book Part 2"</p> <p>5. Reads and writes CD-RW discs conforming to "Orange Book Part 3"</p> <p>6. Reads data in DVD-ROM</p> <p>Applicable DVD formats (Read):</p> <p>DVD: DVD-ROM, (DVD-5, DVD-9, DVD-10, DVD-18),DVD-Video, DVD-R 3.95G, DVD-R 4.7G, DVD-RW, DVD+R, DVD+RW, Multi-Border DVD-R/DVD-RW, Multi-session DVD+R, DVD+RW and DVD-RAM (optional)</p> <p>Applicable CD Formats (Read):</p> <p>CD: CD-DA, CD-ROM Mode-1, CD-ROM/XA Mode Mode-2 Form-1 and Mode-2 Form-2, CD-i Ready, Video-CD (MPEG-1), Karaoke CD, Super Video CD, Photo-CD, Enhanced CD, CD Plus, CD Extra, i-trax CD, CD-Text, CD-R, CD-RW</p> <p>Applicable CD Formats (Write)</p> <p>CD-DA, CD-ROM Mode-1, CD-ROM/XA Mode-2 Form-1 and Mode-2 Form-2, CD-i, Video-CD CD-Text</p>
Loading mechanism	<p>Load: Manual</p> <p>Release: (a) Electrical Release (Release Button)</p> <p>              (b) Release by ATAPI command</p> <p>              (c) Emergency Release</p>
Power Requirement	
Input Voltage	5 V +/- 5 % (Operating)

### Super-Multi Drive module

Item	Specification	
Vendor & model name	HLDS Super-Multi Drive GSA-T20N, PHILIPS Super-Multi Drive DS-8A1P, PIONEER Super-Multi Drive DVR-K17RS	
Performance Specification	With CD Diskette	With DVD Diskette
Transfer rate (KB/sec)	Sustained: Max 3.6Mbytes/sec	Sustained: Max 10.08Mbytes/sec
Buffer Memory	2MB	
Interface	PATA	
Applicable disc format	<p>Applicable disc format</p> <p>CD: CD-DA, CD-ROM, CD-ROM XA, PhotoCD (multi-session), Video CD, Cd-Extra (CD+), CD-text</p> <p>DVD: DVD-VIDEO, DVD-ROM, DVD-R (3.9GB, 4.7GB) DVD-R DL, DVD-RW, DVD-RAM, DVD+R, DVD+R DL, DVD+RW</p> <p>CD:</p> <p>CD-DA (Red Book) - Standard Audio CD &amp; CD-TEXT</p> <p>CD-ROM (Yellow Book Mode1 &amp; 2) - Standard Data</p> <p>CD-ROM XA (Mode2 Form1 &amp; 2) - Photo CD, Multi-Session</p> <p>CD-I (Green Book, Mode2 Form1 &amp; 2, Ready, Bridge)</p> <p>CD-Extra/ CD-Plus (Blue Book) - Audio &amp; Text/Video</p> <p>Video-CD (White Book) - MPEG1 Video</p> <p>CD-R (Orange Book Part )</p> <p>CD-RW &amp; HSRW (Orange Book Part Volume1 &amp; Volume 2</p> <p>Super Audio CD (SACD) Hybrid type</p> <p>US &amp; US+ RW</p> <p>DVD:</p> <p>DVD-ROM (Book 1.02), DVD-Dual</p> <p>DVD-Video (Book 1.1)</p> <p>DVD-R (Book 1.0, 3.9G)</p> <p>DVD-R (Book 2.0, 4.7G) - General &amp; Authoring</p> <p>DVD+R (Version 1.0)</p> <p>DVD+RW</p> <p>DVD-RW (Non CPRM &amp; CPRM)</p> <p>DVD<sup>o</sup>R Dual</p>	
Loading mechanism	<p>Load: Manual</p> <p>Release: (a) Electrical Release (Release Button)</p> <p style="padding-left: 40px;">(b) Release by ATAPI command</p> <p style="padding-left: 40px;">(c) Emergency Release</p>	
Power Requirement		
Input Voltage	5 V +/- 5 % (Operating)	

### Audio Interface

Item	Specification
Audio Controller	Realtek ALC883 Azalia and Amplifier Maxim MAX9710 & MAX4411
Audio onboard or optional	Built-in
Mono or Stereo	Stereo



### Audio Interface

Item	Specification
Resolution	18 bit stereo full duplex
Compatibility	HD audio Interface; S/PDIF output for PCM or AC-3 content
Sampling rate	1Hz resolution VSR (Variable Sampling Rate)
Internal microphone	Yes
Internal speaker / Quantity	Yes/2 (1.5W speakers)

### Video Interface

Item	Specification
Chipset	ATI M66/M74/M76 MXM
Package	Daughter Board
Interface	PCIE
Supports ZV (Zoomed Video) port	Yes

### Video Memory

Item	Specification
Chipset	ATI M66/M74/M76 MXM
Memory size	up to 256MB
Interface	GDDR2

Item	Specification
Chipset	ICH8M
USB Compliancy Level	2.0
OHCI	USB 1.1 and USB 2.0 Host controller
Number of USB port	4
Location	One on the left side/three on the rear side
Serial port function control	Enable/Disable by BIOS Setup

### PCMCIA Port

Item	Specification
PCMCIA controller	ENE CB714/1410
Supports card type	Type-II
Number of slots	One type-II
Access location	Left panel
Supports ZV (Zoomed Video) port	No ZV support
Supports 32 bit CardBus	Yes

### System Board Major Chips

Item	Controller
Core logic	AMD M690G / ATI SB600

## System Board Major Chips

Item	Controller
VGA	ATI M66/M74/M76 MXM
LAN	Realtek 8100SBL/CL
USB 2.0	Intel ICH8M
Super I/O controller	N/A
MODEM	ALC 883
Bluetooth	Built-in ATI SB460
Wireless 802.11 b+g	Built-in ATI SB460
PCMCIA/ 5 in 1 Card Reader	ENE CB714/1410
Audio Codec	Realtek ALC883

## Keyboard

Item	Specification
Keyboard controller	NS PC97541V
Total number of keypads	105-/106-key
Windows logo key	Yes
Internal & external keyboard work simultaneously	Plug USB keyboard to the USB port directly: Yes

## Battery

Item	Specification
Vendor & model name	Panasonic (6cell) 2.0 Sanyo (6cell) 2.0 SMP (6cell) 2.0 Panasonic (8cell) 2.4 Sanyo (8cell) 2.4 SMP (8cell) 2.4
Battery Type	Li-ion
Pack capacity	4000 mAH Panasonic (6cell) 2.0 4000 mAH Sanyo (6cell) 2.0 4000 mAH SMP (6cell) 2.0 4800 mAH Panasonic (8cell) 2.4 4800 mAH Sanyo (8cell) 2.4 4800 mAH SMP (8cell) 2.4
Number of battery cell	6/8
Package configuration	3 cells in series, 2 series in parallel 4 cells in series, 2 series in parallel
Normal voltage	11.1V
Charge voltage	19.0 v

## LCD 17" inch

Item	Specification	
Vendor & model name	B170PW03 (Glare) LTN170X2-L02-1-1 (Glare) LP171WP4-TLB1 (Glare)	B170PW03 (Non-Glare) LTN170X2-L02-1 (Non-Glare) LP171WP4-TLA1 (Non-Glare)
Screen Diagonal (mm)	17 inches	17 inches
Active Area (mm)	331.1 x 207.0	331.2x207
Display resolution (pixels)	1280 x 800 WXGA	1280x800 WXGA
Pixel Pitch	0.2588 0.2588	0.25875x0.25875
Pixel Arrangement	R.G.B. Vertical Stripe	R.G.B. Vertical Stripe
Display Mode	Normally White	Normally White
Typical White Luminance (cd/m <sup>2</sup> ) also called Brightness	200	200
Luminance Uniformity	1.25 max.	1.4
Contrast Ratio	400 typical	400
Response Time (Optical Rise Time/Fall Time)msec	4/12	16
Nominal Input Voltage VDD	+3.3V	3.3V
Typical Power Consumption (watt)	6.0 max. (without inverter)	Total 5.6 Watt (Typ.) @ LCM circuit 1.4Watt (Typ.), Backlight 4.2 Watt (Typ.)
Weight	525 g. typical	560 g.(Typ.) 575 g.(Max)
Physical Size(mm)	344.0 x 222.0 x 6.1	344.0 x 222.0 x 6.5
Electrical Interface	1 channel LVDS	1 channel LVDS
Support Color	262,144	262,144
Viewing Angle (degree) Horizontal: Right/Left Vertical: Upper/Lower	45/45 15/35	45/45 15/35
Temperature Range(° C) Operating Storage (shipping)	0 to +50 -20 to +60	0 to +50 -20 to +60

## LCD Inverter

Item	Specification
Vendor & model name	Darfon/V189-301GP
Brightness conditions	N/A
Input voltage (V)	9~21
Input current (mA)	2.56 (max)
Output voltage (V, rms)	780V (2000V for kick off)
Output current (mA, rms)	6.5 (max)
Output voltage frequency (k Hz)	65K Hz (max)

---

### AC Adaptor

Item	Specification
Input rating	90V AC to 264V AC, 47Hz to 63Hz
Maximum input AC current	1.7A
Inrush current	220A@115VAC 220A@230VAC
Efficiency	82% min. @115VAC input full load

### System Power Management

ACPI mode	Power Management
Mech. Off (G3)	All devices in the system are turned off completely.
Soft Off (G2/S5)	OS initiated shutdown. All devices in the system are turned off completely.
Working (G0/S0)	Individual devices such as the CPU and hard disc may be power managed in this state.
Suspend to RAM (S3)	CPU set power down VGA Suspend PCMCIA Suspend Audio Power Down Hard Disk Power Down CD-ROM Power Down Super I/O Low Power mode
Save to Disk (S4)	Also called Hibernation Mode. System saves all system states and data onto the disc prior to power off the whole system.

# System Utilities

## BIOS Setup Utility

The BIOS Setup Utility is a hardware configuration program built into your computer's BIOS (Basic Input/Output System).

Your computer is already properly configured and optimized, and you do not need to run this utility. However, if you encounter configuration problems, you may need to run Setup. Please also refer to Chapter 4 Troubleshooting when problem arises.

To activate the BIOS Utility, press **F2** during POST (when "Press <F2> to enter Setup" message is prompted on the bottom of screen).

Press **F2** to enter setup. The default parameter of F12 Boot Menu is set to "disabled". If you want to change boot device without entering BIOS Setup Utility, please set the parameter to "enabled".

Press <F12> during POST to enter multi-boot menu. In this menu, user can change boot device without entering BIOS SETUP Utility.

Phoenix TrustedCore(tm) Setup Utility					
Information	Main	Advanced	Security	Boot	Exit
CPU Type:	Mobile AMD Sempron (tm)				
CPU Speed:	1800 MHz				
IDE0 Model Name:	XXXXXXXXXXXX-(XX)				
IDE0 Serial Number:	XXXXXXXX				
IDE1 Model Name:	None				
IDE1 Serial Number:	None				
ATAPI Model Name:	XXXXXXXXXXXX-XXX XX-XXXX-(XX)				
System BIOS Version:	VX.XX				
VGA BIOS Version:	XX-XX XXXXX.XXX.XXX.XXX.XXXXXX				
KBC Version:	XX.XX				
Serial Number:	XXXXXXXXXXXXXXXXXXXXXXXXXXXX				
Asset Tag Number:	None				
Product Name:	TravelMate 5XXX				
Manufacturer Name:	Acer				
UUID:	XXXxXxXX-xXxX-XXxx-xXXx-xXXxXXxXxxXX				
<b>F1</b> Help <b>↑↓</b> Select Item <b>-/+</b> Change Values <b>F9</b> Setup Defaults <b>Esc</b> Exit <b>←→</b> Select Menu <b>Enter</b> Select <b>▶</b> Sub-Menu <b>F10</b> Save and Exit					

---

## Navigating the BIOS Utility

There are six menu options: Information, Main, Advanced, Security, Boot, and Exit.

Follow these instructions:

- To choose a menu, use the left and right arrow keys.
- To choose an item, use the up and down arrow keys.
- To change the value of a parameter, press **F5** or **F6**.
- A plus sign (+) indicates the item has sub-items. Press **Enter** to expand this item.
- Press **Esc** while you are in any of the menu options to go to the Exit menu.
- In any menu, you can load default settings by pressing **F9**. You can also press **F10** to save any changes made and exit the BIOS Setup Utility.

**NOTE:** You can change the value of a parameter if it is enclosed in square brackets. Navigation keys for a particular menu are shown on the bottom of the screen. Help for parameters are found in the Item Specific Help part of the screen. Read this carefully when making changes to parameter values. **Please note that system information is subject to different models.**

# Information

The Information screen displays a summary of your computer hardware information.

Phoenix TrustedCore(tm) Setup Utility

Information
Main
Advanced
Security
Boot
Exit

```

CPU Type:           Mobile AMD Sempron (tm)
CPU Speed:          1800 MHz
IDE0 Model Name:    XXXXXXXXXXXX-(XX)
IDE0 Serial Number: XXXXXXXXX
IDE1 Model Name:    None
IDE1 Serial Number: None
ATAPI Model Name:   XXXXXXXXXXXX-XXX XX-XXXX-(XX)
System BIOS Version: VX.XX
VGA BIOS Version:  XX-XXX XXXXXX.XXX.XXX.XXX.XXXXXX
KBC Version:       XX.XX
Serial Number:     XXXXXXXXXXXXXXXXXXXXXXXXXXXX
Asset Tag Number:  None
Product Name:      TravelMate 5XXX
Manufacturer Name: Acer
UUID:              XXXxXxXX-xXxX-XXxx-xXXx-xXXxXXxXxxXX
                
```

F1 Help    ↑↓ Select Item    -/+ Change Values    F9 Setup Defaults  
Esc Exit    ←→ Select Menu    Enter Select    ▶ Sub-Menu    F10 Save and Exit

**NOTE:** The system information is subject to different models.

Parameter	Description
CPU Type	This field shows the CPU type and speed of the system.
CPU Speed	This field shows the speed of the CPU.
IDE0 Model Name	This field shows the model name of HDD installed on primary IDE master.
IDE0 Serial Number	This field displays the serial number of HDD installed on primary IDE master.
IDE1 Model Name	This field displays the model name of devices installed on secondary IDE master. The hard disk drive or optical drive model name is automatically detected by the system.
IDE1 Serial Number	This field shows the serial number of devices installed on secondary IDE master.
ATAPI Model Name	This field shows the model name of the Optical device installed in the system.
System BIOS Version	Displays system BIOS version.
VGA BIOS Version	This field displays the VGA firmware version of the system.
KBC Ver	This field shows the keyboard
Serial Number	This field displays the serial number of this unit.
Asset Tag Number	This field displays the asset tag number of the system.
Product Name	This field shows product name of the system.
Manufacturer Name	This field displays the manufacturer of this system.
UUID Number	Universally Unique Identifier (UUID) is an identifier standard used in software construction, standardized by the Open Software Foundation (OSF) as part of the Distributed Computing Environment (DCE).

# Main

The Main screen allows the user to set the system time and date as well as enable and disable boot option and recovery.

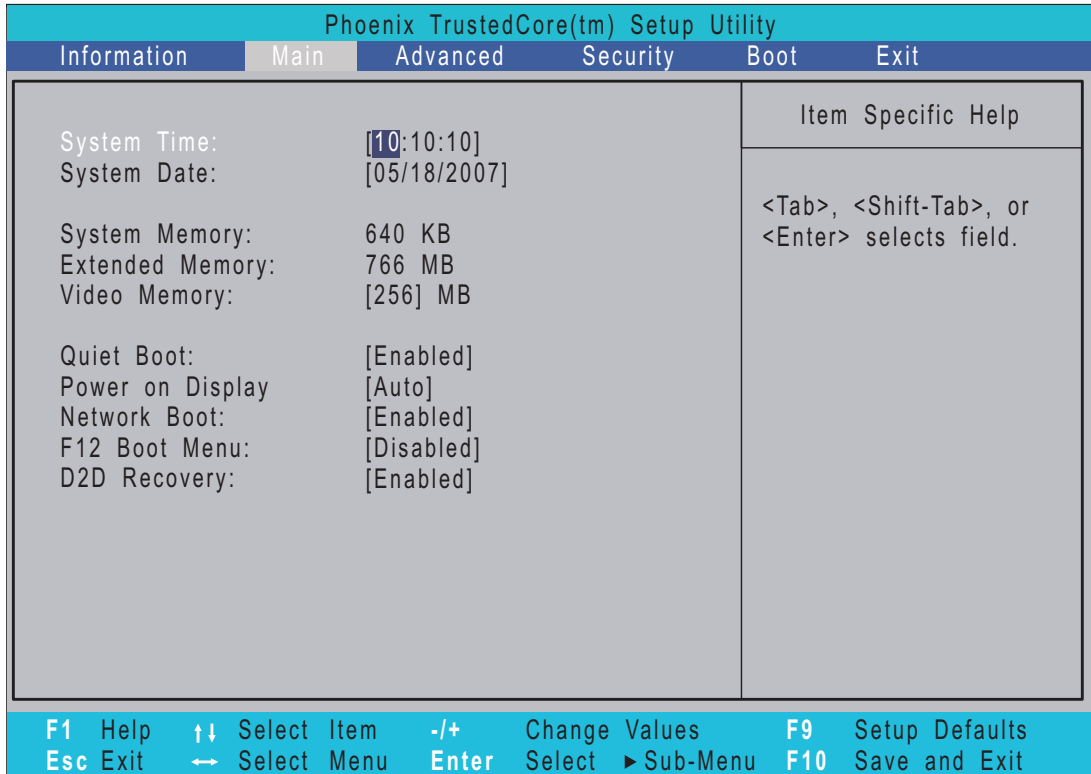

**NOTE:** The screen above is for your reference only. Actual values may differ.



The table below describes the parameters in this screen. Settings in **boldface** are the default and suggested parameter settings.

Parameter	Description	Format/Option
System Time	Sets the system time. The hours are displayed with 24-hour format.	Format: HH:MM:SS (hour:minute:second) System Time
System Date	Sets the system date.	Format MM/DD/YYYY (month/day/year) System Date
System Memory	This field reports the memory size of the system. Memory size is fixed to 640MB	
Extended Memory	This field reports the memory size of the extended memory in the system. Extended Memory size=Total memory size-1MB	
VGA Memory	Shows the VGA memory size. VGA Memory size=128/256 MB	
Quiet Boot	Determines if Customer Logo will be displayed or not; shows Summary Screen is disabled or enabled.  Enabled: Customer Logo is displayed, and Summary Screen is disabled. Disabled: Customer Logo is not displayed, and Summary Screen is enabled.	Option: <b>Enabled</b> or Disabled
Power on Display	Set the display output device on boot up.	Option: <b>Auto</b> or Both
Network Boot	Enables, disables the system boot from LAN (remote server).	Option: <b>Enabled</b> or Disabled
F12 Boot Menu	Enables, disables Boot Menu during POST.	Option: <b>Disabled</b> or Enabled
D2D Recovery	Enables, disables D2D Recovery function. The function allows the user to create a hidden partition on hard disc drive to store operation system and restore the system to factory defaults.	Option: <b>Enabled</b> or Disabled

**NOTE:** The sub-items under each device will not be shown if the device control is set to disable or auto. This is because the user is not allowed to control the settings in these cases.

# Advanced

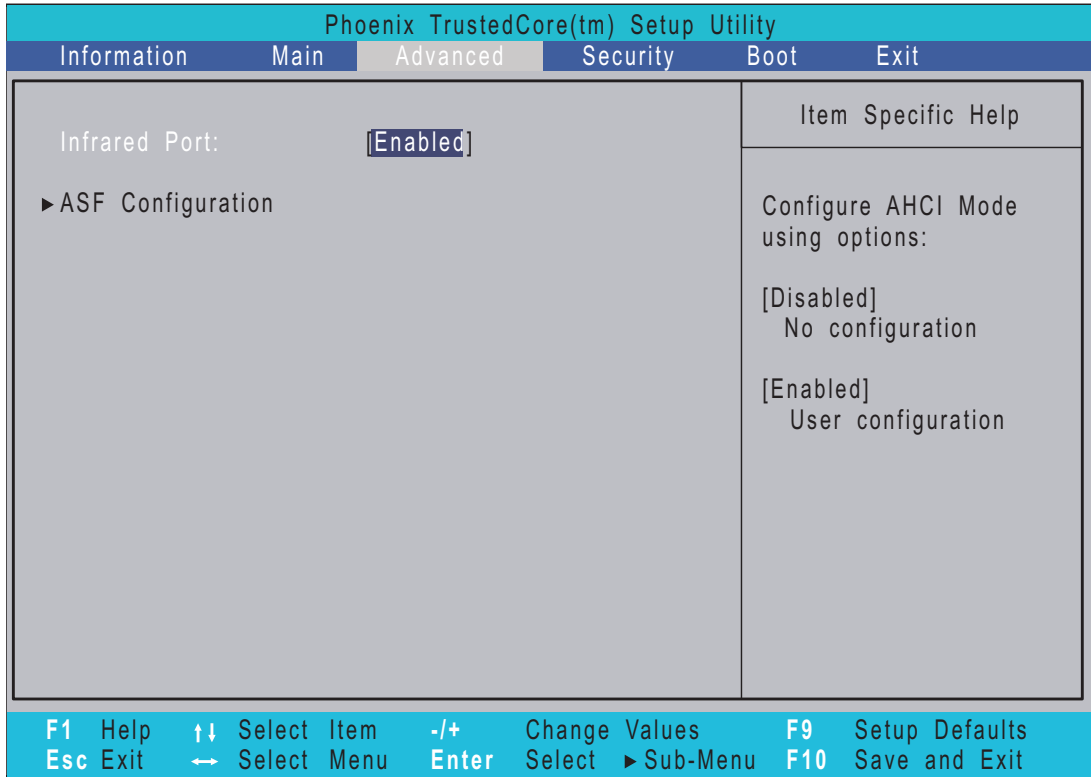

The table below describes the parameters in this screen. Settings in **boldface** are the default and suggested parameter settings.

Parameter	Description	Format/Option
Infrared Port	Enable or Disable the infrared port	Option: <b>Enabled</b> or Disabled
ASF Configuration	Configure Alert Standard Format (ASF) parameters. A standard for how alerting and remote-control capabilities on network controllers work Options: Minimum WatchDog Timeout: [ ] BIOS Boot Timeout: [ ] OS Boot Timeout: [ ] Power-on wait time: [ ]	

# Security

The Security screen contains parameters that help safeguard and protect your computer from unauthorized use.

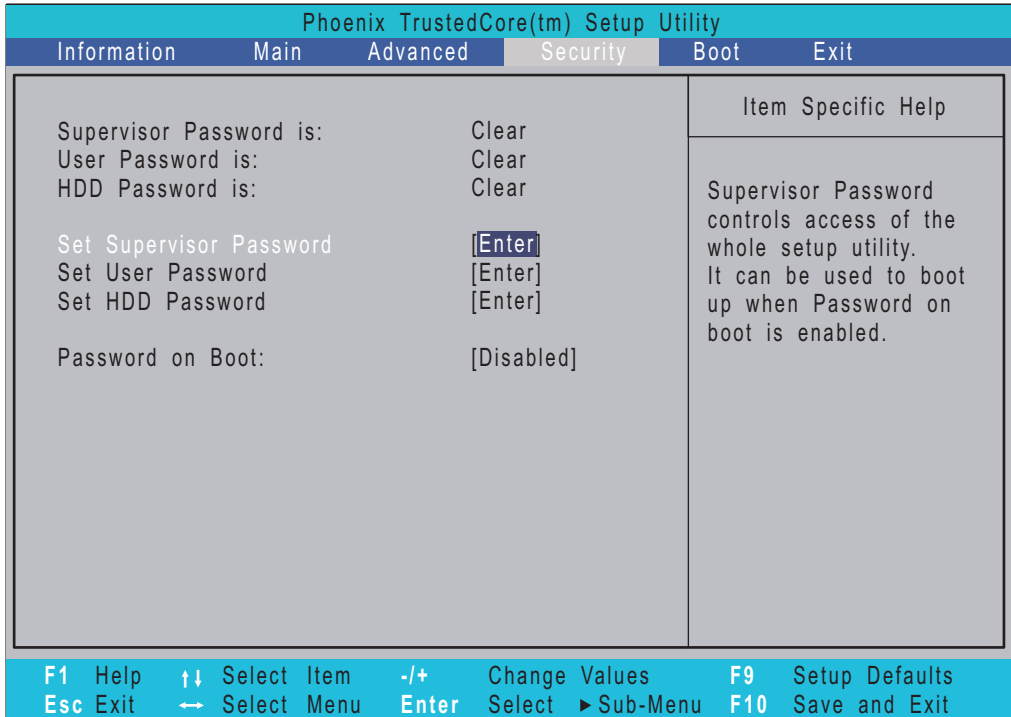

**NOTE:** Please refer to "Remove HDD/BIOS Password" section if you need to know how to remove HDD/BIOS Password.

The table below describes the parameters in this screen. Settings in **boldface** are the default and suggested parameter settings.

Parameter	Description	Option
Supervisor Password is	Shows the setting of the Supervisor password	<b>Clear</b> or Set
User Password is	Shows the setting of the user password.	<b>Clear</b> or Set
HDD Password is	Shows the setting of the hard disk drive password	<b>Clear</b> or Set
Set Supervisor Password	Press Enter to set the supervisor password. When set, this password protects the BIOS Setup Utility from unauthorized access. The user can not either enter the Setup menu nor change the value of parameters.	
Set User Password	Press Enter to set the user password. When user password is set, this password protects the BIOS Setup Utility from unauthorized access. The user can enter Setup menu only and does not have right to change the value of parameters.	
Set HDD Password	Press Enter to set the HDD password.	
Password on Boot	Defines whether a password is required or not while the events defined in this group happened. The following sub-options are all requires the Supervisor password for changes and should be grayed out if the user password was used to enter setup.	<b>Disabled</b> or Enabled

**NOTE:** When you are prompted to enter a password, you have three tries before the system halts. Don't forget your password. If you forget your password, you may have to return your notebook computer to your dealer to reset it.

## Setting a Password

Follow these steps as you set the user or the supervisor password:

1. Use the **w** and **y** keys to highlight the Set Supervisor Password parameter and press the **e** key. The Set Supervisor Password box appears:

```

Set Supervisor Password

Enter New Password   [           ]

Confirm New Password [           ]
```

2. Type a password in the "Enter New Password" field. The password length can not exceeds 8 alphanumeric characters (A-Z, a-z, 0-9, not case sensitive). Retype the password in the "Confirm New Password" field.

**IMPORTANT:** Be very careful when typing your password because the characters do not appear on the screen.

3. Press **e**.  
After setting the password, the computer sets the User Password parameter to "Set".
4. If desired, you can opt to enable the Password on boot parameter.
5. When you are done, press **u** to save the changes and exit the BIOS Setup Utility.

---

## Removing a Password

Follow these steps:

1. Use the `w` and `y` keys to highlight the Set Supervisor Password parameter and press the `e` key. The Set Password box appears:

Set Supervisor Password		
Enter current password	[	]
Enter New Password	[	]
Confirm New Password	[	]

2. Type the current password in the Enter Current Password field and press `e`.
3. Press `e` twice **without** typing anything in the Enter New Password and Confirm New Password fields. The computer then sets the Supervisor Password parameter to "Clear".
4. When you have changed the settings, press `u` to save the changes and exit the BIOS Setup Utility.

## Changing a Password

1. Use the `w` and `y` keys to highlight the Set Supervisor Password parameter and press the `e` key. The Set Password box appears:

Set Supervisor Password		
Enter current password	[	]
Enter New Password	[	]
Confirm New Password	[	]

2. Type the current password in the Enter Current Password field and press `e`.
3. Type a password in the Enter New Password field. Retype the password in the Confirm New Password field.
4. Press `e`. After setting the password, the computer sets the User Password parameter to "Set".
5. If desired, you can enable the Password on boot parameter.
6. When you are done, press `u` to save the changes and exit the BIOS Setup Utility.

If the verification is OK, the screen will display as following.

Setup Notice	
Changes have been saved.	
[ continue]	

The password setting is complete after the user presses `u`.

---

If the current password entered does not match the actual current password, the screen will show you the Setup Warning.



Setup Warning  
Invalid password  
Re-enter Password  
[ continue]

A rectangular dialog box with a black border containing four lines of centered text.

If the new password and confirm new password strings do not match, the screen will display the following message.

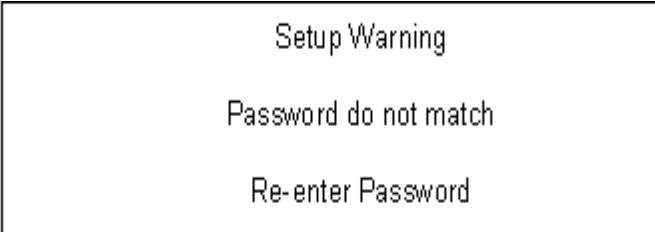

Setup Warning  
Password do not match  
Re-enter Password

A rectangular dialog box with a black border containing three lines of centered text.

# Boot

This menu allows the user to decide the order of boot devices to load the operating system. Bootable devices includes the distette drive in module bay, the onboard hard disk drive and the CD-ROM in module bay.

Phoenix TrustedCore(tm) Setup Utility					
Information	Main	Advanced	Security	Boot	Exit
Boot priority order: 1: IDE0: XXXXXXXXXXXX-(XX) 2: IDE1: 3: CD/DVD: XXXXXXXXXXXX-XXX XX-XXXX-XX 4: PCI LAN: MBA vXX.X.X Slot XXXX 5: USB HDD: 6: USB FDD: 7: USB Key: 8: USB CD/DVD ROM:				Item Specific Help Use <↑> or <↓> to select a device, then press <F6> to move it up the list, or <F5> to move it down the list. Press <Esc> to escape the menu.	
F1 Help	↑↓ Select Item	-/+ Change Values	F9 Setup Defaults		
Esc Exit	←→ Select Menu	Enter Select	▶ Sub-Menu	F10 Save and Exit	

# Exit

The Exit screen contains parameters that help safeguard and protect your computer from unauthorized use.

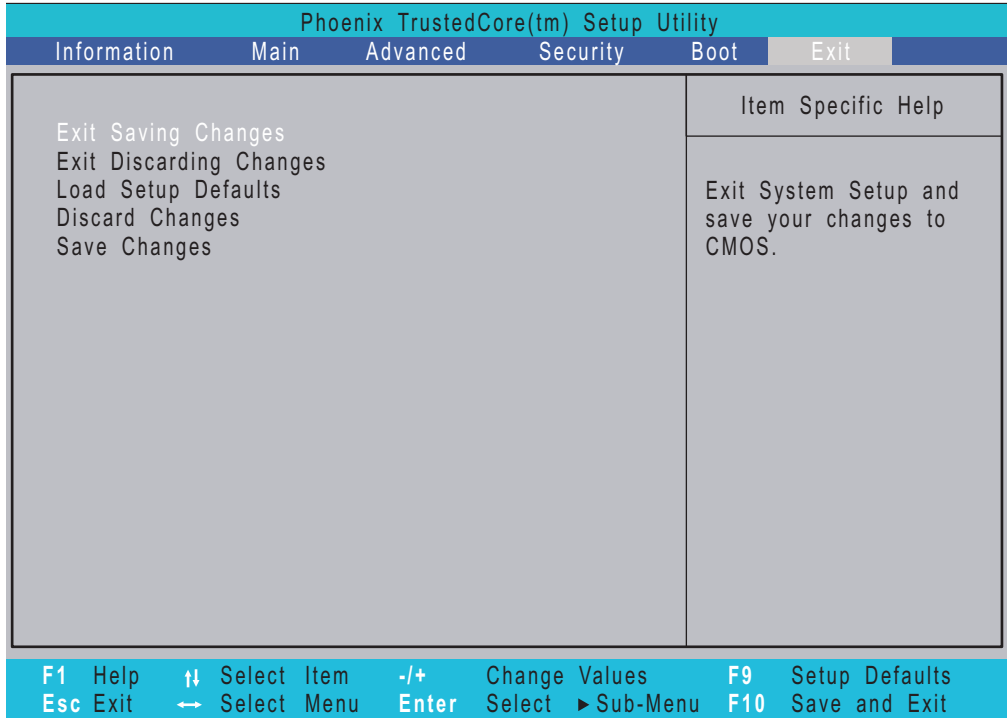

The table below describes the parameters in this screen.

Parameter	Description
Exit Saving Changes	Exit System Setup and save your changes to CMOS.
Exit Discarding Changes	Exit utility without saving setup data to CMOS.
Load Setup Default	Load default values for all SETUP item.
Discard Changes	Load previous values from CMOS for all SETUP items.
Save Changes	Save Setup Data to CMOS.



---

# BIOS Flash Utility

The BIOS flash memory update is required for the following conditions:

- New versions of system programs
- New features or options
- Restore a BIOS when it becomes corrupted.

Use the Phlash utility to update the system BIOS flash ROM.

**NOTE:** If you do not have a crisis recovery diskette at hand, then you should create a **Crisis Recovery Diskette** before you use the Phlash utility.

**NOTE:** Do not install memory-related drivers (XMS, EMS, DPMS) when you use the Phlash.

**NOTE:** Please use the AC adaptor power supply when you run the Phlash utility. If the battery pack does not contain enough power to finish BIOS flash, you may not boot the system because the BIOS is not completely loaded.

Follow the steps below to run the Phlash.

1. Prepare a bootable diskette.
2. Copy the flash utilities to the bootable diskette.
3. Then boot the system from the bootable diskette. The flash utility has auto-execution function.

# Remove HDD/BIOS Utility

This section provide you with removing HDD/BIOS method:

## Remove HDD Password:

- ❑ If you key in wrong HDD password for three time, “HDD password error code” would display on the screen. See the image below.

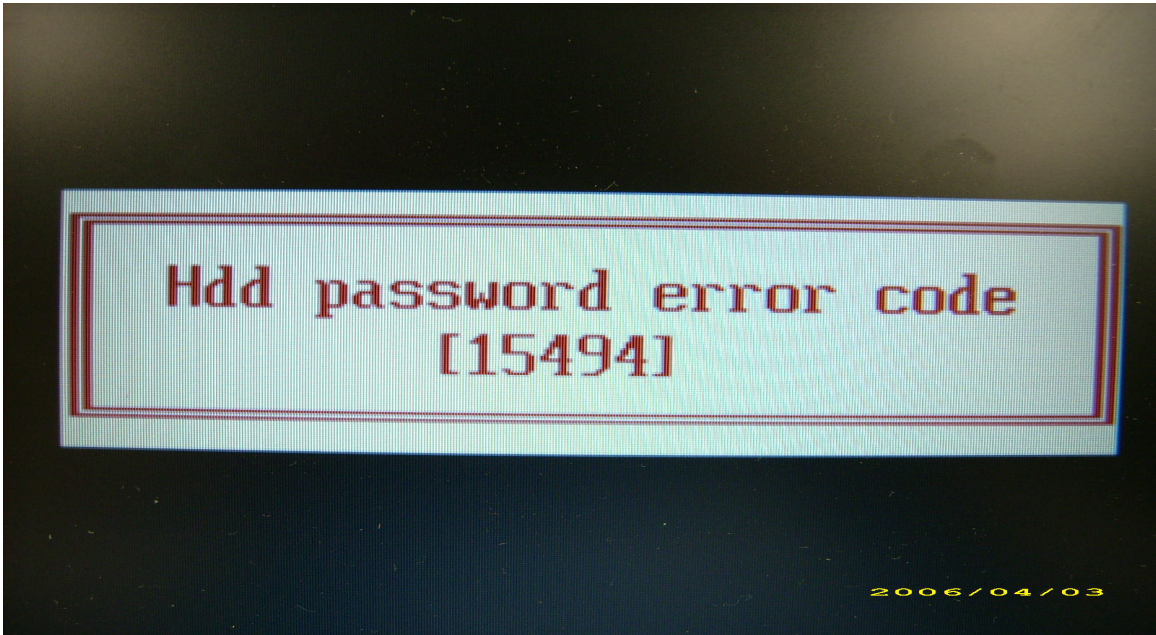

- ❑ If you need to solve HDD password locked problem, you can run HDD\_PW.EXE
  1. Key in “hdd\_pw 15494 0”
  2. Select “2”
  3. Choose one upper-case string

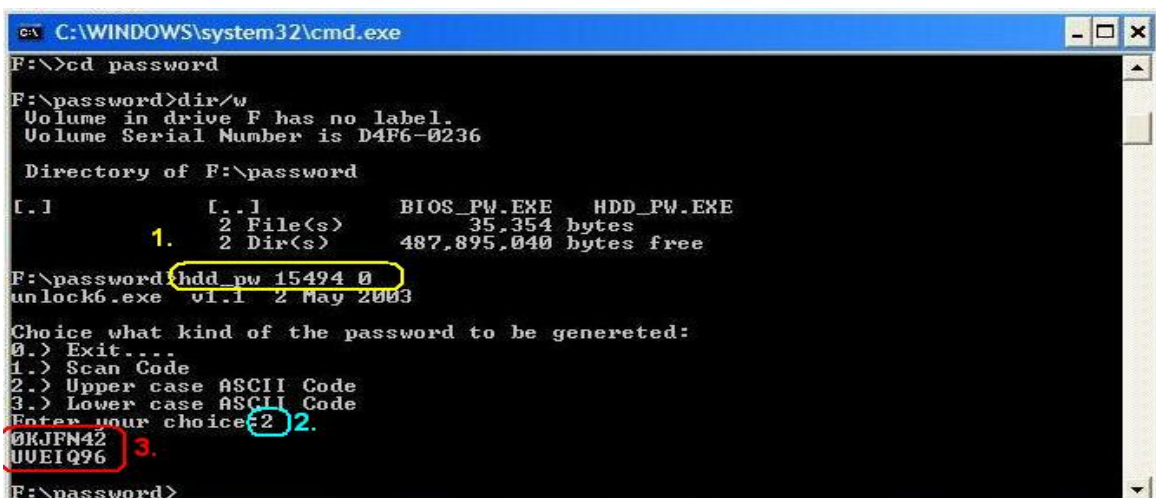

- ❑ Reboot system and key in “0KJFN42” or “UVEIQ96” to HDD user password.

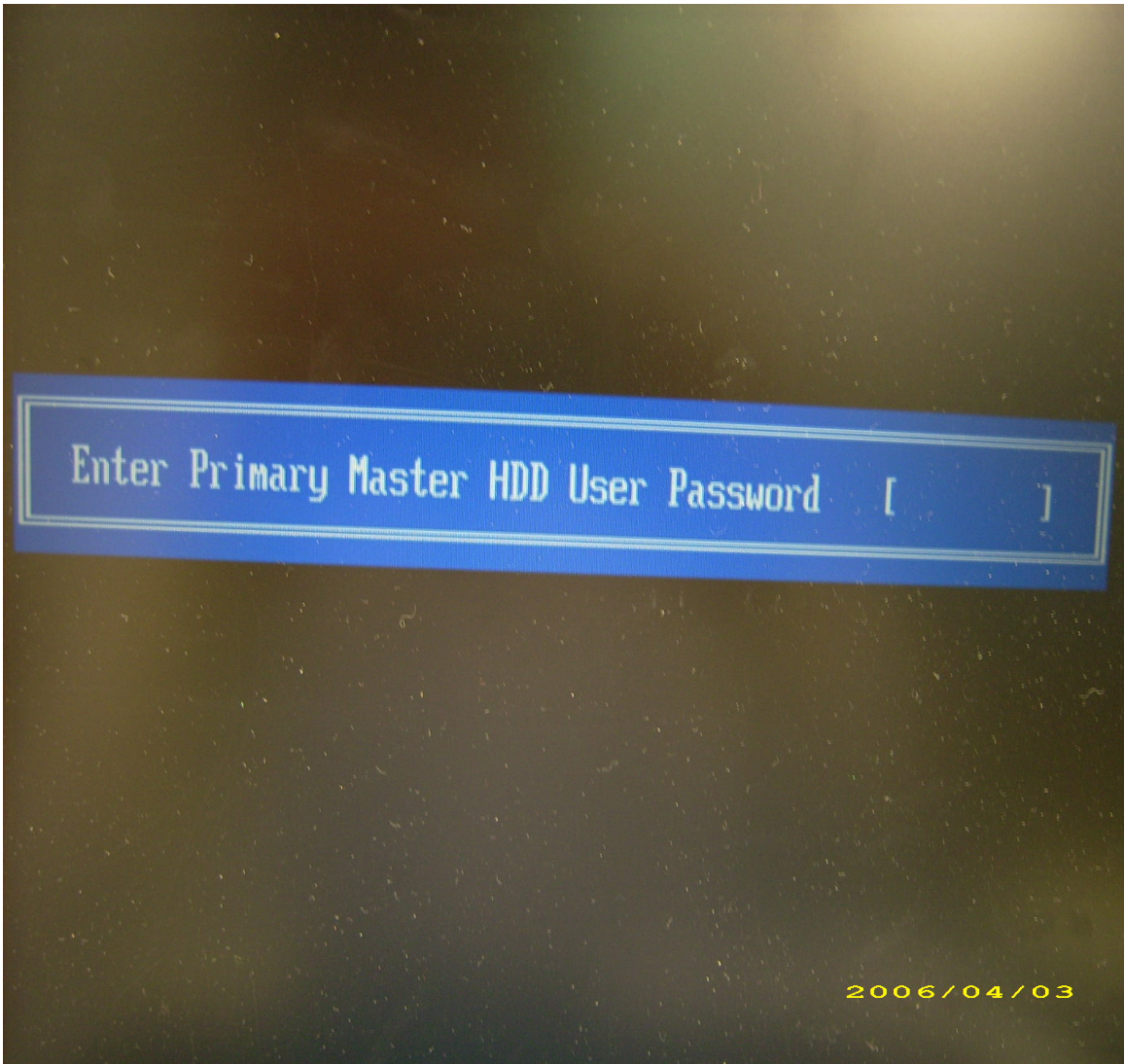

**Remove BIOS Password:**

- If you key in wrong Supervisor Password for three time, "System Disabled" would display on the screen. See the image below.



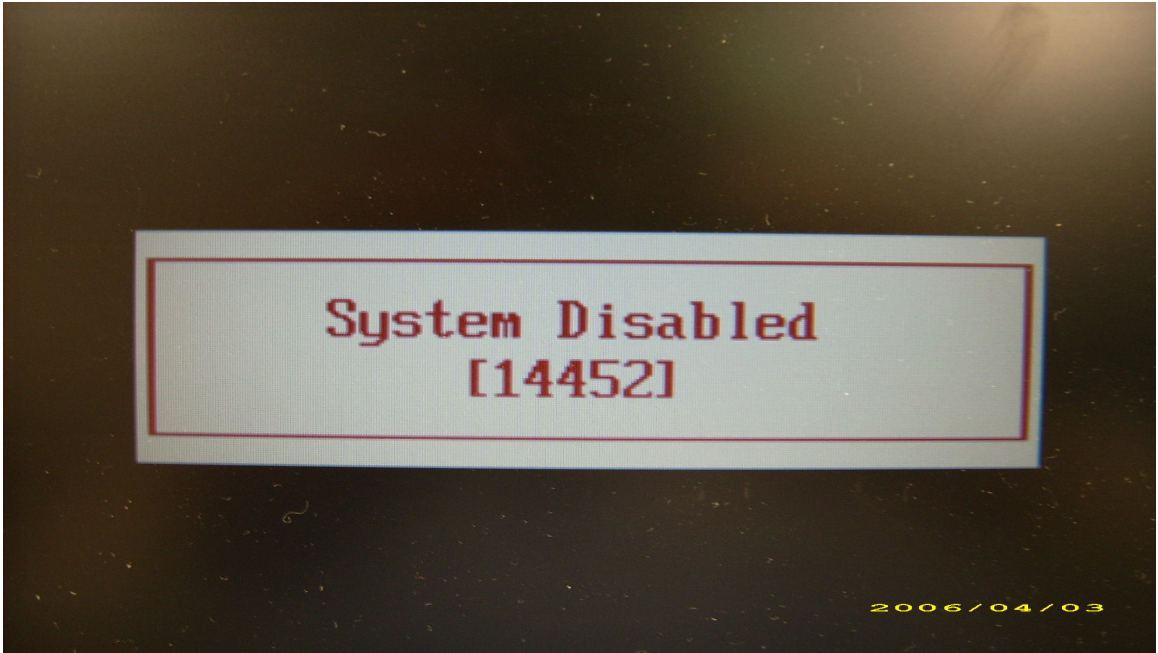

- If you need to solve BIOS password locked problem, you can run BIOS\_PW.EXE
  1. Key in "bios\_pw 14452 0"
  2. Choose one upper-case string

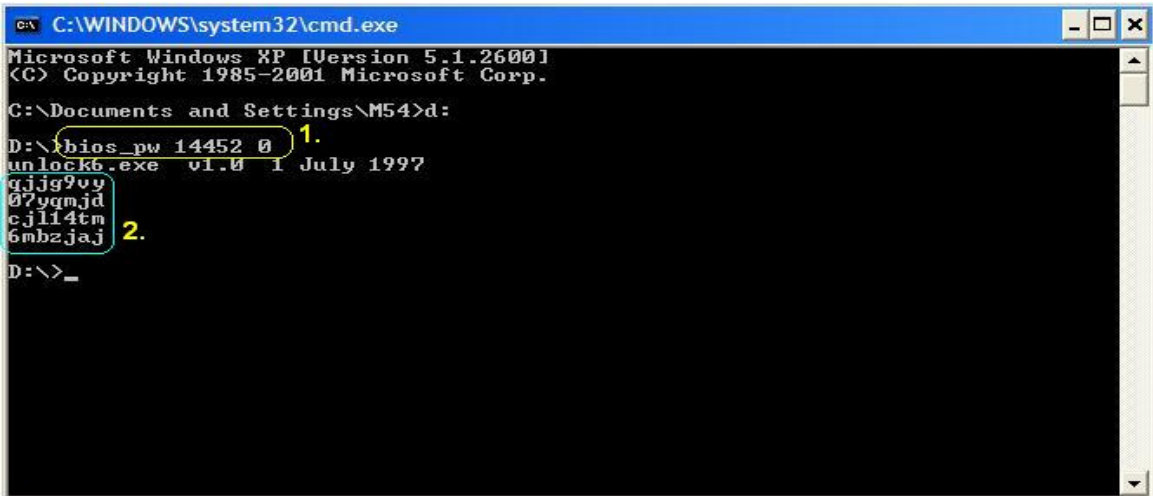

- Reboot the system and key in "qjgg9vy" or "07yqmjd" to BIOS user password.





# Machine Disassembly and Replacement

---

This chapter contains step-by-step procedures on how to disassemble the notebook computer for maintenance and troubleshooting.

## Disassembly Requirements

To disassemble the computer, you need the following tools:

- Wrist grounding strap and conductive mat for preventing electrostatic discharge
- Flat screwdriver
- Philips screwdriver
- Hex screwdriver
- Plastic flat screwdriver
- Plastic tweezers

**NOTE:** The screws for the different components vary in size. During the disassembly process, group the screws with the corresponding components to avoid mismatch when putting back the components.

# General Information

## Pre-disassembly Instructions

Before proceeding with the disassembly procedure, make sure that you do the following:

1. Turn off the power to the system and all peripherals.
2. Unplug the AC adapter and all power and signal cables from the system.



3. Place the system on a flat, stable surface.
4. Remove the battery pack.

## Disassembly Process

The disassembly process is divided into the following stages:

- External module disassembly
- Main unit disassembly
- LCD module disassembly

The flowcharts provided in the succeeding disassembly sections illustrate the entire disassembly sequence. Observe the order of the sequence to avoid damage to any of the hardware components. For example, if you want to remove the main board, you must first remove the keyboard, then disassemble the inside assembly frame in that order.

### Main Screw List

Item	Screw	Color	Part No.
A	M2.5 x L6	Black	86.00E33.736
B	M2 x L4	Black	86.00A02.140
C	M2 x L4	Silver	86.9A552.4R0
D	M2.5 x L5	Silver	86.00E74.335
E	M2.5 x L5	Black	86.00F19.735
F	M2 x L3	Silver	86.00C07.220
G	M3 x L4	Silver	86.9A544.4R0
H	M2.5 x L8	Black	86.00E34.738
I	M2 x L6	Silver	86.9A552.6R0
J	M2 x L4	Black	86.00F24.724
K	M2 x L3	Black	86.00E94.723



# External Module Disassembly Process

## External Modules Disassembly Flowchart

The flowchart below gives you a graphic representation on the entire disassembly sequence and instructs you on the components that need to be removed during servicing. For example, if you want to remove the main board, you must first remove the keyboard, then disassemble the inside assembly frame in that order.

### EXTERNAL MODULE DISASSEMBLY

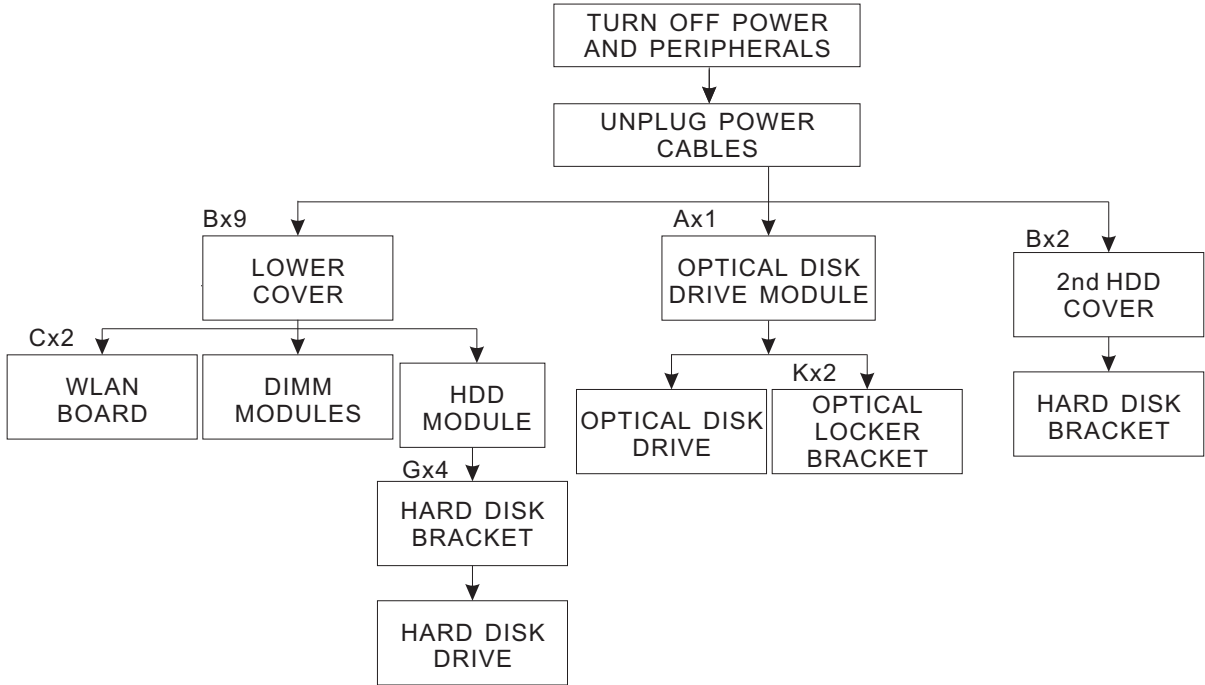

### Screw List

	Screw	Part No.
A	M2.5 x L6	86.00E33.736
B	M2 x L4	86.00A02.140
C	M2 x L4	86.9A552.4R0
G	M3 x L4	86.9A544.4R0
K	M3 x L3	86.00E94.723

---

## Removing the Battery Pack

1. Turn base unit over.
2. Slide the battery lock/unlock latch to the unlock position.



3. Slide and hold the battery release latch to the release position, then remove the battery from the main unit.



---

## Removing the SD dummy card

1. Push the SD dummy card all the way in to eject it (1, 2).

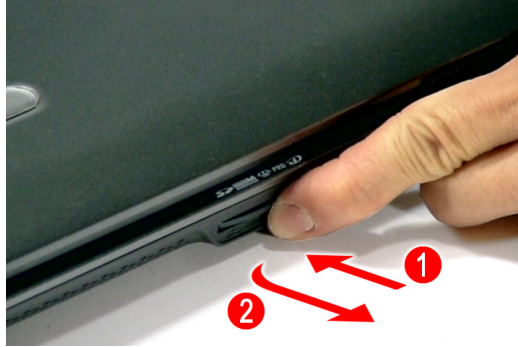

2. Pull it out from the slot (2).



## Removing the PC and ExpressCard dummy cards

1. Press the eject button to pop out the button.



2. Press it again (1) to pop out the PC dummy card (2). Remove the PC dummy card from the slot.



3. Push the ExpressCard dummy card all the way in to eject it.



4. Pull it out from the slot.



## Removing the Lower Cover

1. See "Removing the Battery Pack" on page 62.

2. See “Removing the SD dummy card” on page 63.
3. See “Removing the PC and ExpressCard dummy cards” on page 63.
4. Loosen the nine screws (B) on the lower cover.

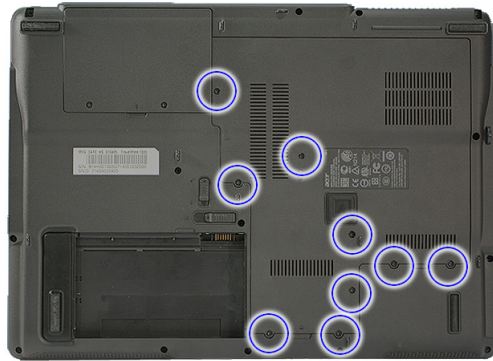

Step	Size (Quantity)	Color	Torque
1~9	M2 x L4 (9)	Black	1.6 kgf-cm

5. Use a plastic screw driver to carefully pry open the lower cover.

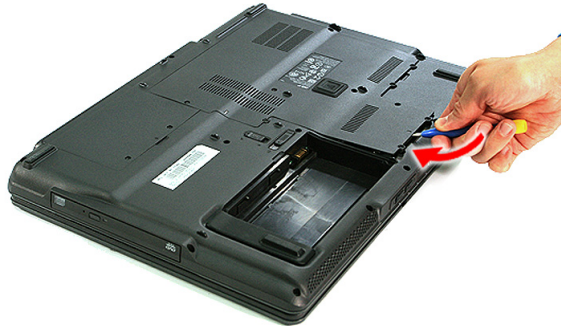

6. Remove the lower cover from the lower case.

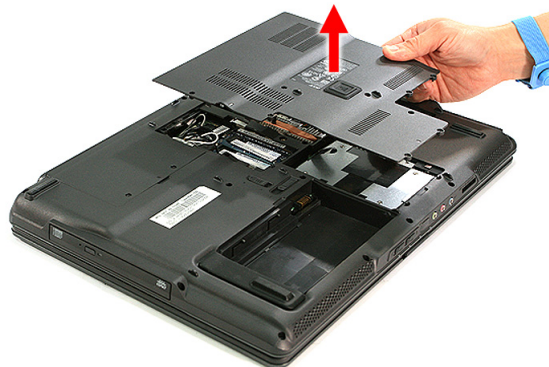

## Removing the Secondary HDD Cover

1. See “Removing the Battery Pack” on page 62.
2. See “Removing the SD dummy card” on page 63.
3. See “Removing the PC and ExpressCard dummy cards” on page 63.
4. See “Removing the Lower Cover” on page 64.

- Loosen the two screws (B) from the secondary HDD cover.

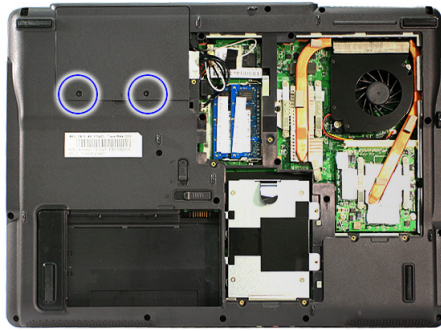

Step	Size (Quantity)	Color	Torque
1~2	M2 x L4 (2)	Black	1.6 kgf-cm

- Use a plastic screw driver to pry open the secondary HDD cover.



- Remove the secondary HDD cover from the lower case.

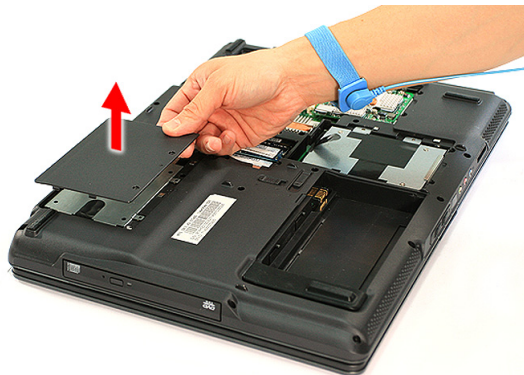

## Removing the Secondary HDD Bracket and Connector

- See "Removing the Battery Pack" on page 62.
- See "Removing the Secondary HDD Cover" on page 65.



3. Remove the HDD Bracket from the slot.



4. Disconnect the SATA power connector.

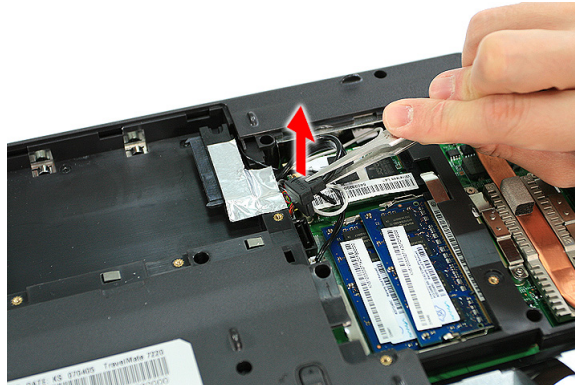

5. Disconnect the SATA connector.

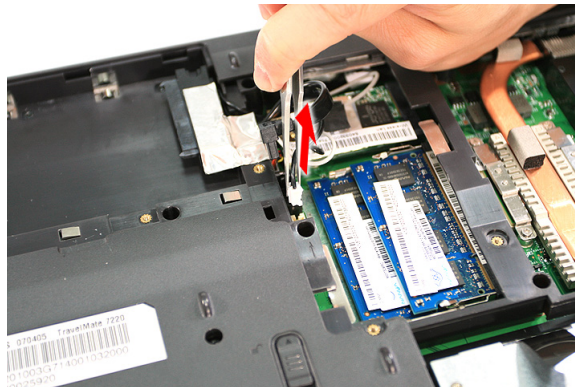

6. Remove the aluminum tape together with the connector.

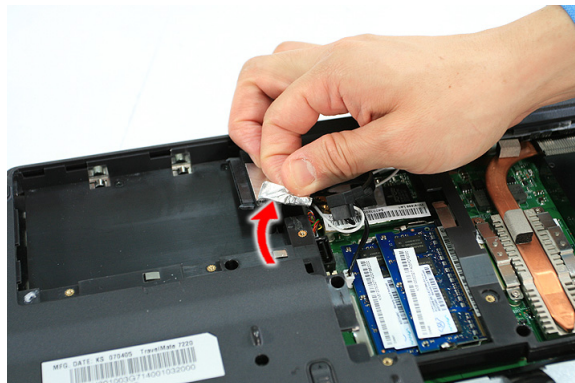

---

## Removing the DIMM

1. See “Removing the Battery Pack” on page 62.
2. See “Removing the SD dummy card” on page 63.
3. See “Removing the PC and ExpressCard dummy cards” on page 63.
4. See “Removing the Lower Cover” on page 64.
5. See “Removing the Secondary HDD Cover” on page 65.
6. Push out the latches on both sides of the DIMM socket to release the DIMM.

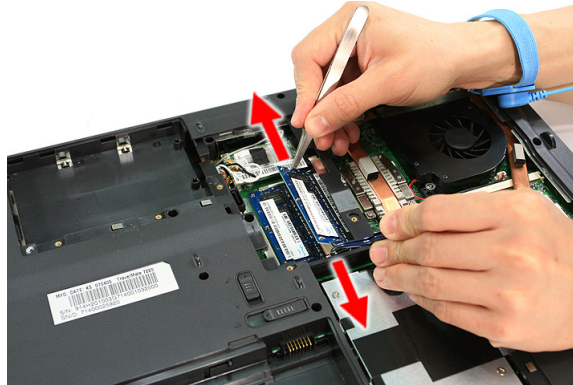

7. Remove the DIMM module.

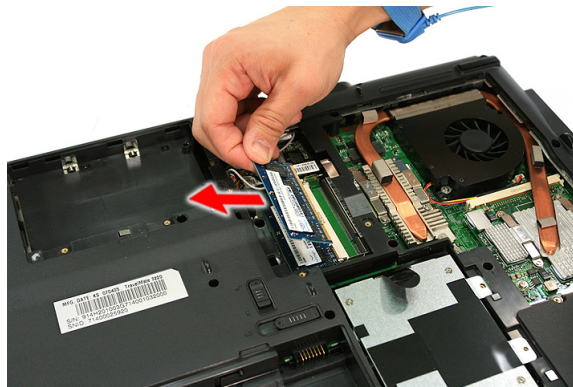

## Removing the WLAN Board Modules

1. See “Removing the Battery Pack” on page 62.
2. See “Removing the SD dummy card” on page 63.
3. See “Removing the PC and ExpressCard dummy cards” on page 63.
4. See “Removing the Lower Cover” on page 64.
5. Remove the tape holding the gray antenna.

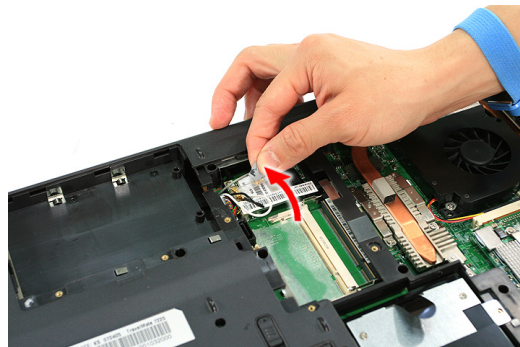



- Disconnect the antenna cables from the WLAN board.

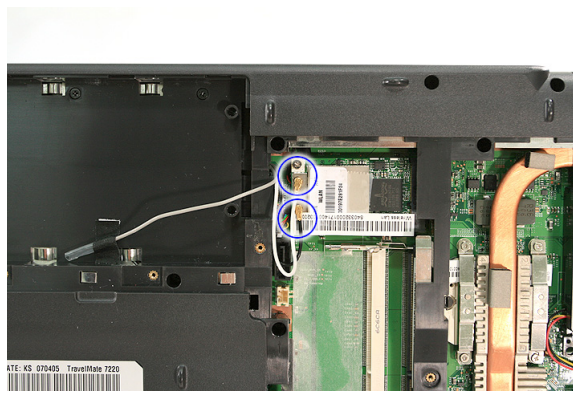

- Move the antenna away from the WLAN board and remove the two screws (C) on the WLAN board to release the WLAN board.

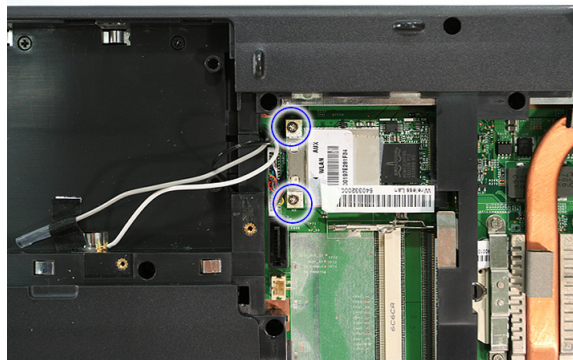

Step	Size (Quantity)	Color	Torque
1~2	M2 x L4 (2)	Silver	1.6 kgf-cm

- Detach the WLAN board from the WLAN socket.

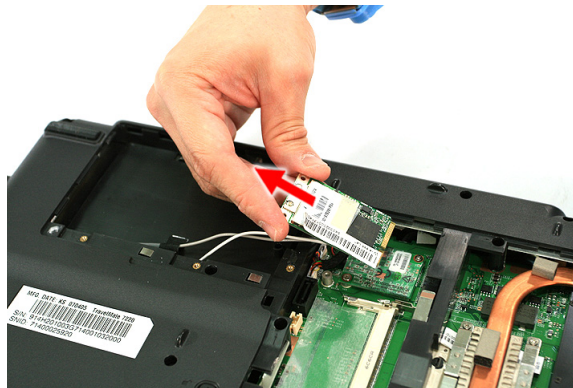

**NOTE:** When attaching the antenna back to the WLAN board, make sure the cable are arranged properly.

## Removing the Hard Disk Drive Module

- See “Removing the Battery Pack” on page 62.
- See “Removing the SD dummy card” on page 63.
- See “Removing the PC and ExpressCard dummy cards” on page 63.
- See “Removing the Lower Cover” on page 64.

- Disconnect the hard disk module from the connector by pulling on the mylar tab on the hard disk module.

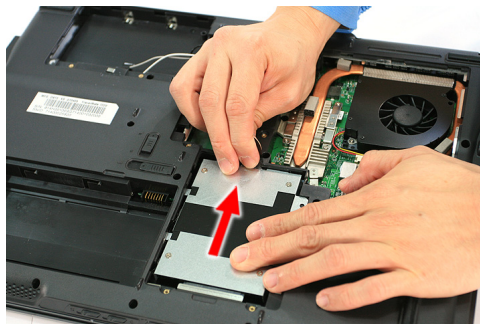

- Remove the hard disk module.

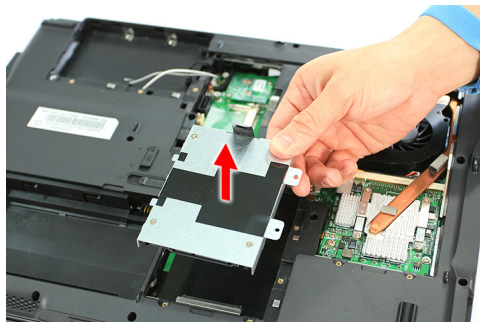

**NOTE:** To prevent damage to device, avoid pressing down on it or placing heavy objects on top of it.

- Remove the four screws (G) as shown.

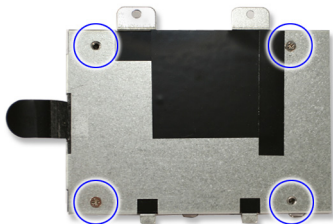

Step	Size (Quantity)	Color	Torque
1~4	M3 x L4 (4)	Silver	1.8 kgf-cm

- Remove the hard disk drive from the bracket.



## Removing the Optical Drive Module

- See “Removing the Battery Pack” on page 62.

2. Turn the base unit over, then remove the one screw (A) on the bottom side of the unit.

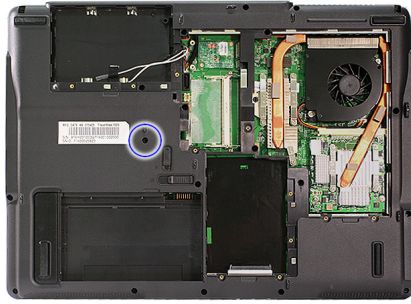

Step	Size (Quantity)	Color	Torque
1	M2.5 x L6 (1)	Black	3.0 kgf-cm

3. Carefully use a plastic screw driver to eject the optical drive tray.

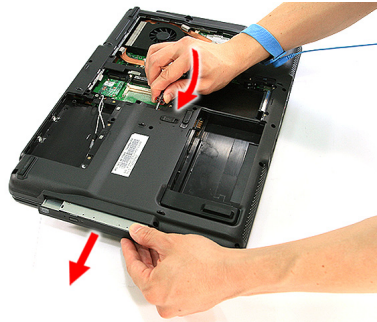

4. Pull the optical drive module out from the main unit.

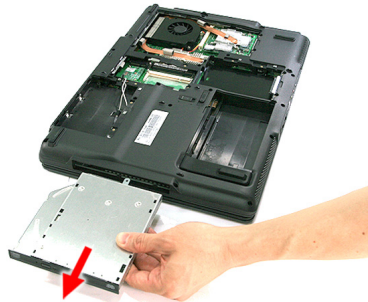

- 
5. Remove the two screws (K) securing the locker bracket and remove the locker bracket from the optical disk drive module.

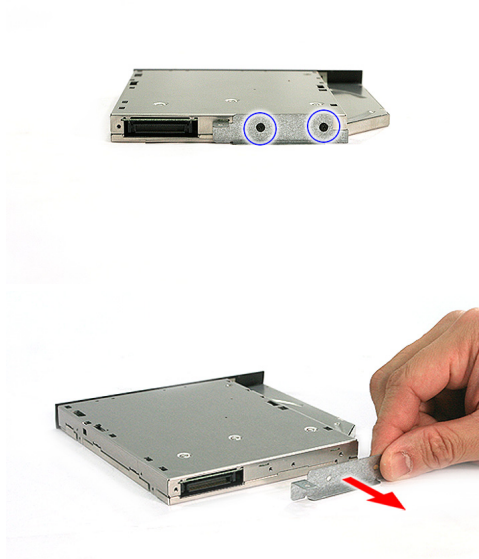

Step	Size (Quantity)	Color	Torque
1~2	M2 x L3 (2)	Black	1.6 kgf-cm

# Main Unit Disassembly Process

## Main Unit Disassembly Flowchart

### MAIN UNIT DISASSEMBLY

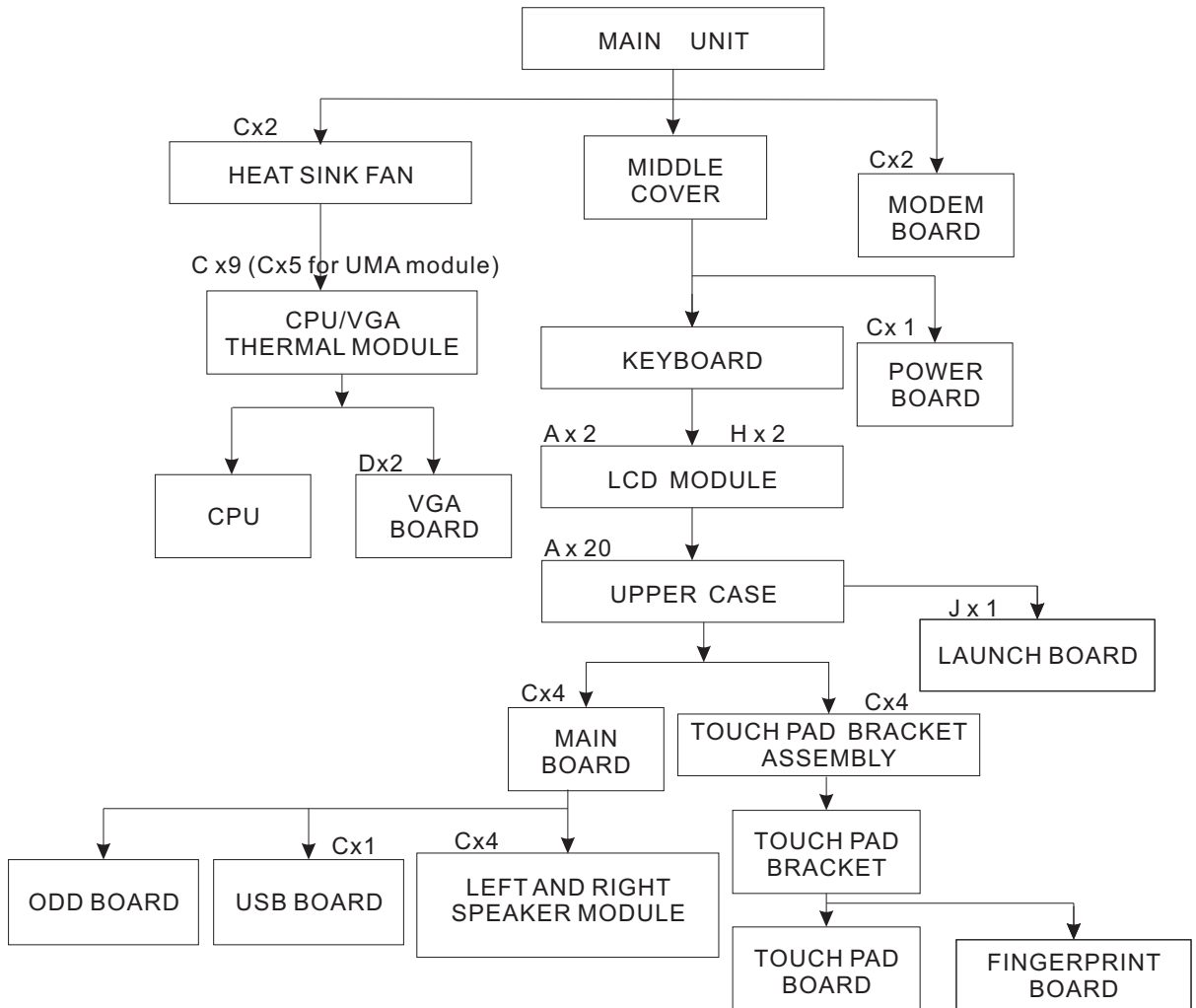

#### Screw List

	Screw	Part No.
A	M2.5 x L6	86.00E33.736
C	M2 x L4	86.9A552.4R0
D	M2.5 x L5	86.00E74.335
H	M2.5 x L8	86.00E34.738
J	M2 x L4	86.00F24.724

## Removing the Modem Board

1. See “Removing the Battery Pack” on page 62.
2. See “Removing the Lower Cover” on page 64.

3. See “Removing the DIMM” on page 68.
4. See “Removing the WLAN Board Modules” on page 68.
5. Remove the 2 screws (C) securing the modem card.

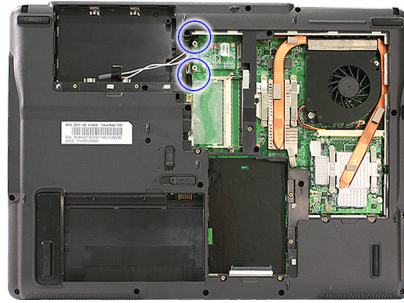

Step	Size (Quantity)	Color	Torque
1~2	M2 x L4 (2)	Silver	1.8 kgf-cm

6. Lift partially to detach the modem board from the main board.

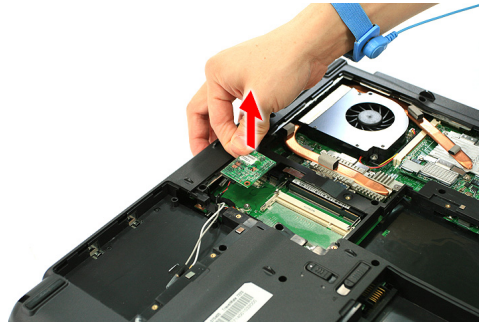

**NOTE:** The modem cable is still attached to the modem board.

7. Disconnect the modem cable from the modem board.

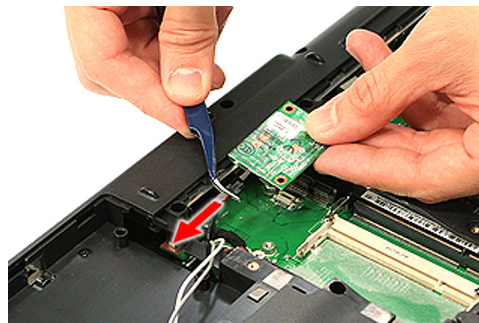

## Removing the Heatsink Fan Module

1. See “Removing the Battery Pack” on page 62.
2. See “Removing the Lower Cover” on page 64.



3. Disconnect the heatsink fan connector from FAN1 on the main board.

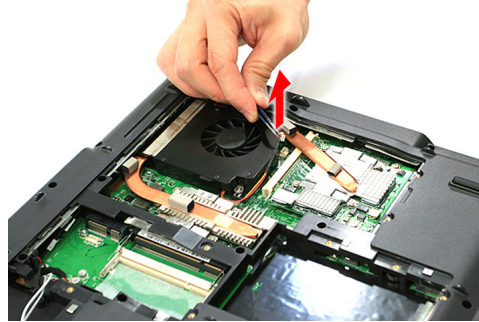

4. Remove the two screws (C) securing the heatsink fan module.

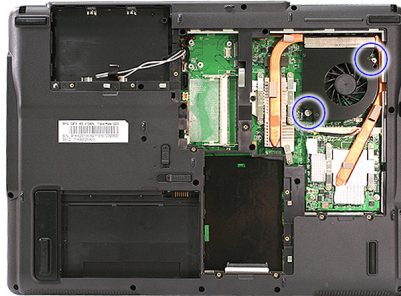

Step	Size (Quantity)	Color	Torque
1~2	M2 x L4 (2)	Silver	1.6 kgf-cm

5. Remove the heatsink fan module from the main board.

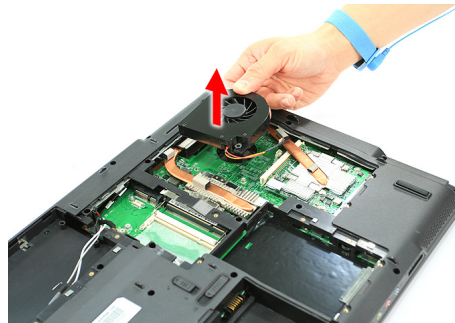

## Removing the CPU and VGA Heatsink Module

1. See “Removing the Battery Pack” on page 62.
2. See “Removing the Lower Cover” on page 64.

- Remove the nine screws (C) securing the CPU and VGA heatsink module in place.

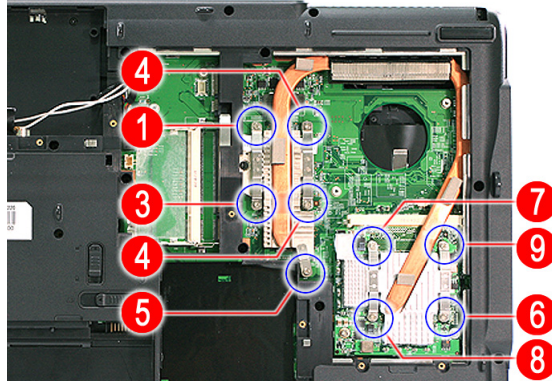

Step	Size (Quantity)	Color	Torque
1~9	M2 x L4 (9)	Silver	3.0 kgf-cm

- Slide out and remove the heatsink module.

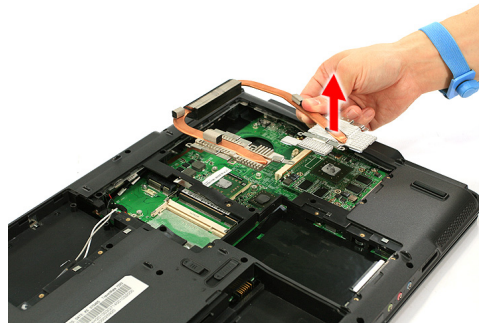
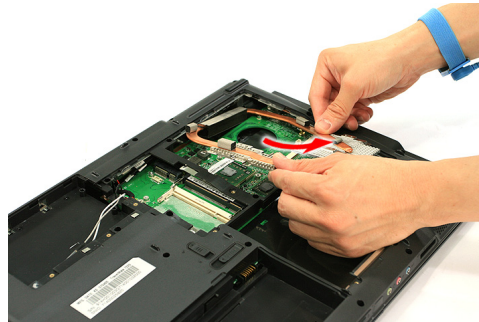

## Removing the CPU

- See "Removing the Battery Pack" on page 62..
- See "Removing the Lower Cover" on page 64..
- See "Removing the Heatsink Fan Module" on page 74.
- See "Removing the CPU and VGA Heatsink Module" on page 75.



- Using a flat screwdriver, turn the CPU socket latch counter-clockwise to release the CPU, then remove the CPU.

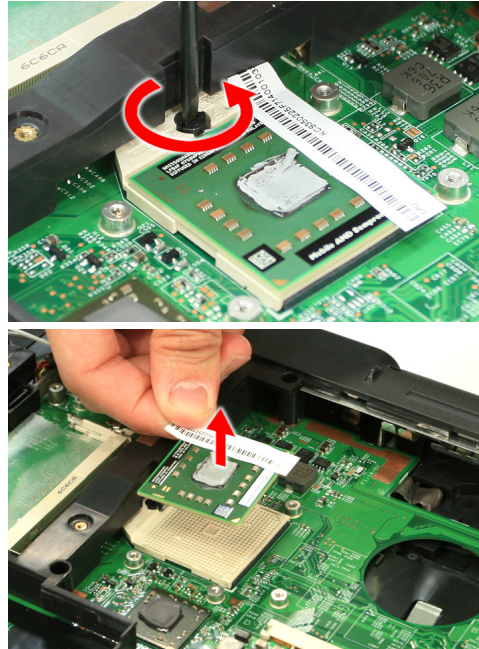

**NOTE:** When installing the CPU, make sure to install the CPU with PIN 1 at the corner as shown.

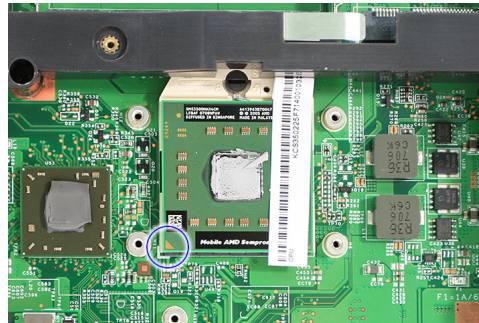

## Removing the VGA board (for Discrete model only)

- See “Removing the Battery Pack” on page 62.
- See “Removing the Lower Cover” on page 64.
- See “Removing the Heatsink Fan Module” on page 74.
- See “Removing the CPU and VGA Heatsink Module” on page 75.
- Remove the two screws (D) securing the VGA board.



Step	Size (Quantity)	Color	Torque
1~2	M2.5 x L5 (2)	Silver	1.6 kgf-cm

6. Carefully remove the VGA board from the main board.

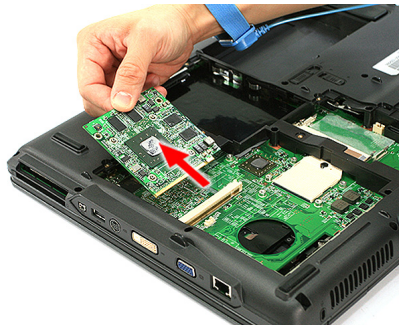

## Removing the Middle Cover and the Power Board

1. See "Removing the Battery Pack" on page 62.
2. Open the LCD screen all the way to facilitate the easy removal of the middle cover.
3. To remove the Middle Cover, carefully insert the plastic flat screwdriver under the side of the middle cover and gently pry up the middle cover. Continue prying on the other side until you could detach the Middle Cover.



4. Detach the cover and turn it over on the keyboard.

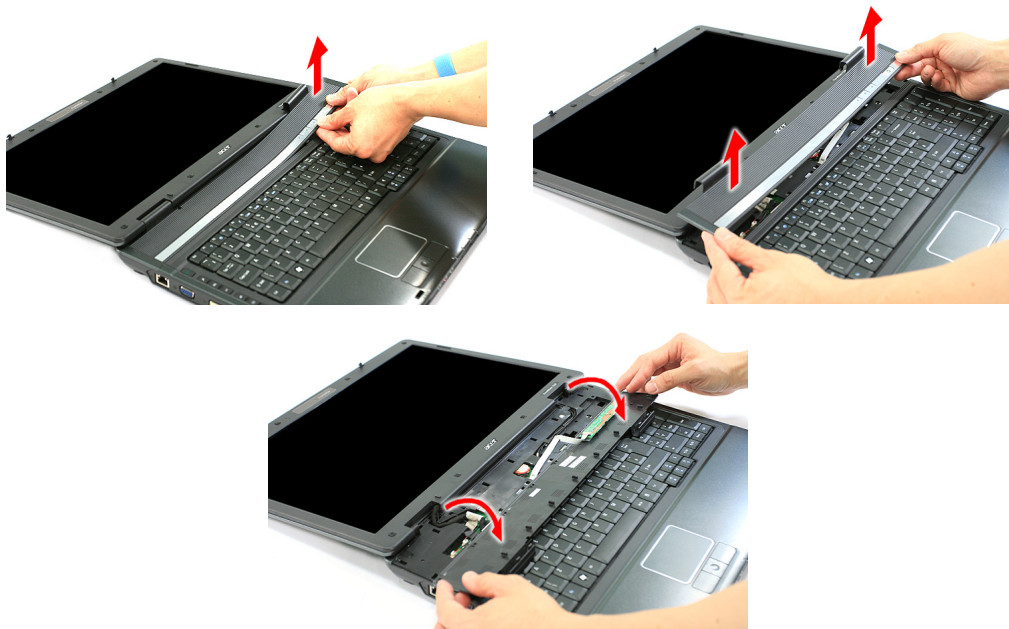

5. Disconnect the Power board cable from the main board and disconnect the Power board cable.

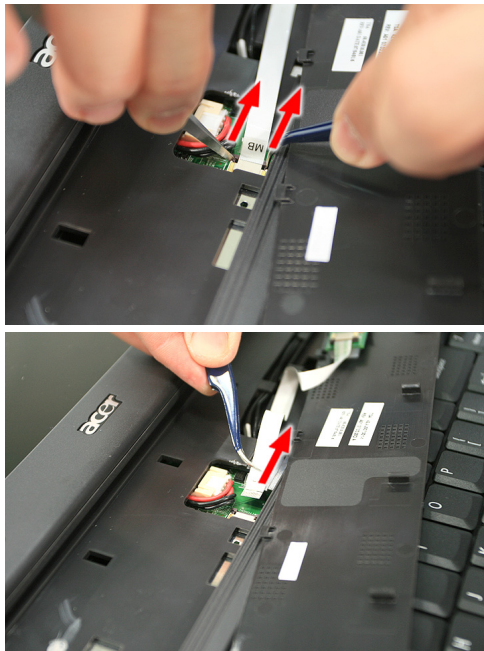

6. Remove the one screw (C) securing the Power board to the middle cover, and remove the Power board from the middle cover.

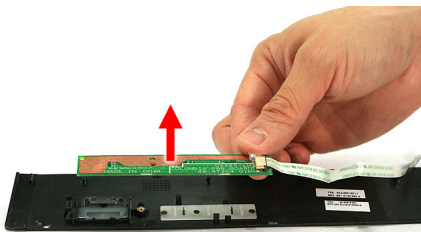
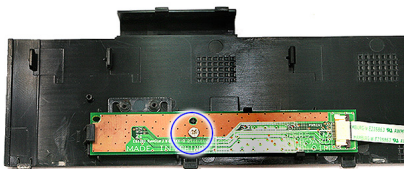

Step	Size (Quantity)	Color	Torque
1	M2 x L4 (1)	Silver	1.6 kgf-cm

### Removing the Keyboard

1. See “Removing the Battery Pack” on page 62..
2. See “Removing the Middle Cover and the Power Board” on page 78.



3. Release the top latches securing the keyboard in place.

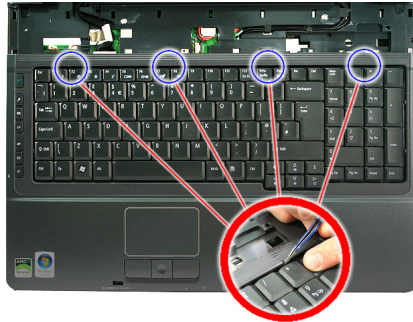

4. Carefully pry the keyboard out of the side latches and slide it out; then turn it over on the touchpad area.

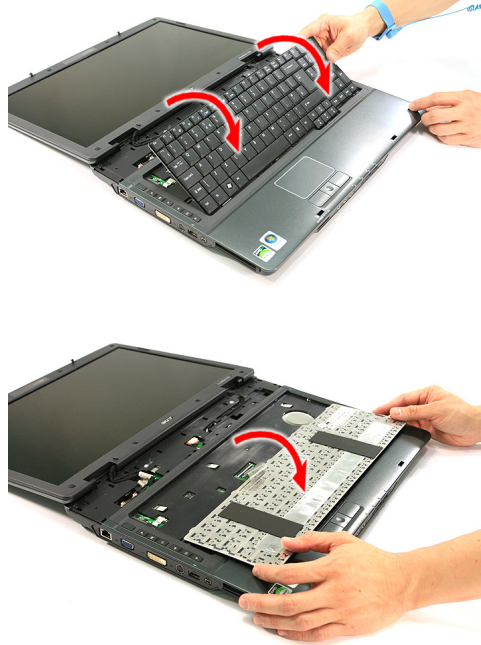

5. Disconnect the keyboard cable from the main board to remove the keyboard.

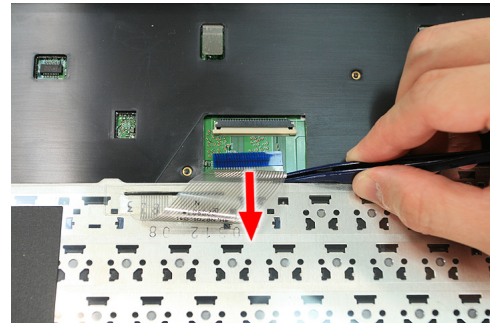
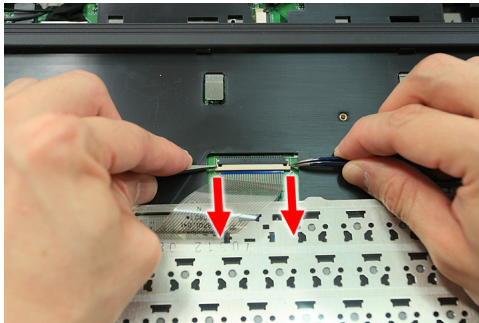

---

## Removing the LCD Module

1. See “Removing the Battery Pack” on page 62.
2. See “Removing the Lower Cover” on page 64.
3. See “Removing the WLAN Board Modules” on page 68.
4. See “Removing the Middle Cover and the Power Board” on page 78.
5. See “Removing the Keyboard” on page 79.
6. Remove the acetic tape and disconnect the LCD coaxial cable from the LCD1 connector on the main board.

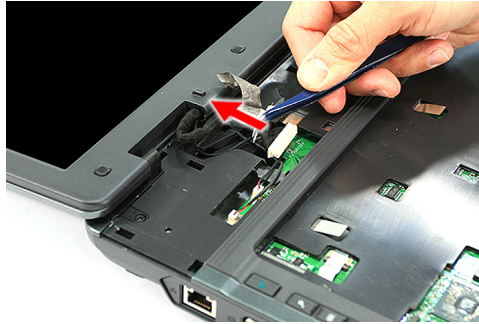

7. Remove the internal microphone cable from the INTMIC1 connector on the main board and release the cables from the latches.

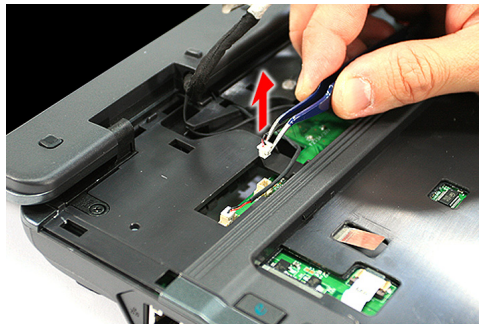

8. Release the wireless LAN antenna cables from the hole and latches as shown.

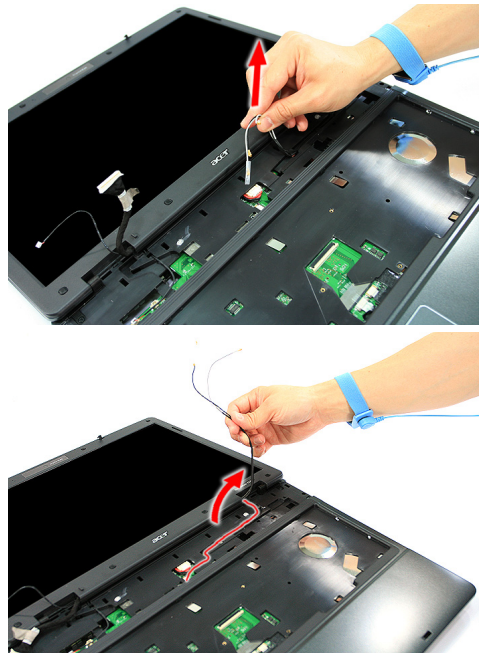

9. Remove the two screws (A) from the base of the unit.

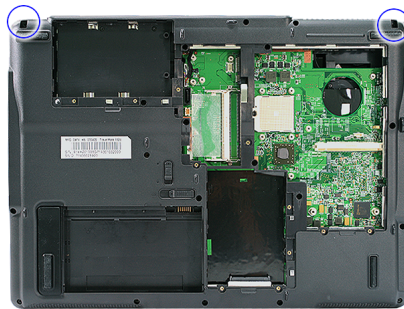

Step	Size (Quantity)	Color	Torque
1~2	M2.5 x L6 (2)	Black	4.0 kgf-cm

10. Remove the two screws (H) from the left and right hinge of the LCD module.

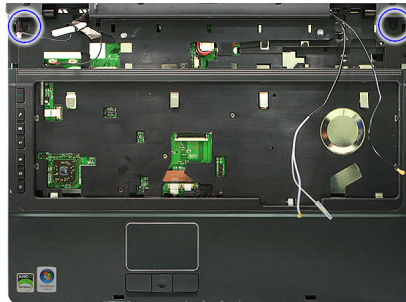

Step	Size (Quantity)	Color	Torque
1~2	M2.5 x L8 (2)	Black	4.0 kgf-cm

- 
11. Carefully remove the LCD module from the base unit.

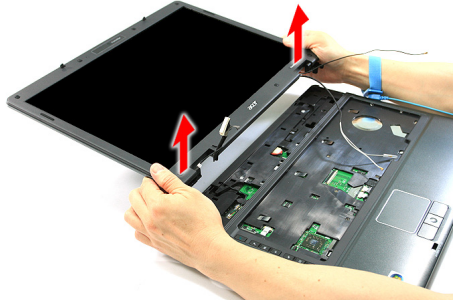

**NOTE:** When connecting the cable back to the unit, please note that the cable should be routed well.

## Separating the Upper Case from the Lower Case

1. See “Removing the Battery Pack” on page 62.
2. See “Removing the SD dummy card” on page 63.
3. See “Removing the PC and ExpressCard dummy cards” on page 63.
4. See “Removing the Lower Cover” on page 64.
5. See “Removing the Secondary HDD Cover” on page 65.
6. See “Removing the Secondary HDD Bracket and Connector” on page 66.
7. See “Removing the DIMM” on page 68.
8. See “Removing the WLAN Board Modules” on page 68.
9. See “Removing the Hard Disk Drive Module” on page 69.
10. See “Removing the Optical Drive Module” on page 70.
11. See “Removing the Modem Board” on page 73.
12. See “Removing the Heatsink Fan Module” on page 74.
13. See “Removing the CPU and VGA Heatsink Module” on page 75.
14. See “Removing the CPU” on page 76.
15. See “Removing the VGA board (for Discrete model only)” on page 77.
16. See “Removing the Middle Cover and the Power Board” on page 78.
17. See “Removing the Keyboard” on page 79.
18. See “Removing the LCD Module” on page 81.
19. Disconnect the cover switch cable from LID1 on the main board.





20. Disconnect the DC in cable from the main board.



21. Disconnect the Launch board cable from the SWITCHCN1 from the main board.

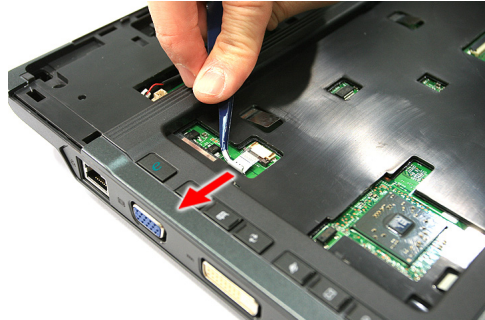
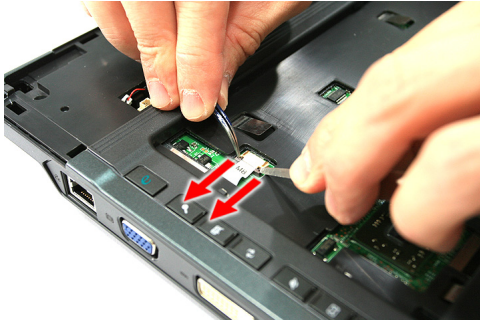

22. Disconnect the fingerprint cable (select model only) from the FPCN1 connector on the main board.

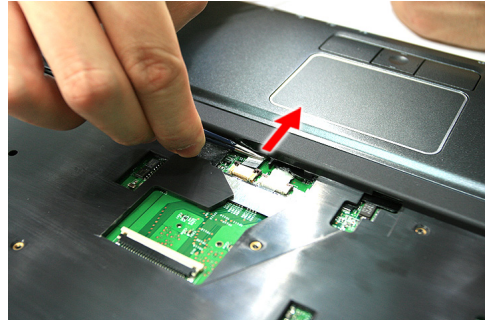
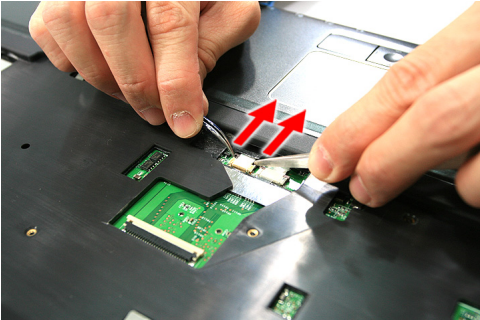

23. Disconnect the touchpad cable from the TOUCHPAD1 on the main board.

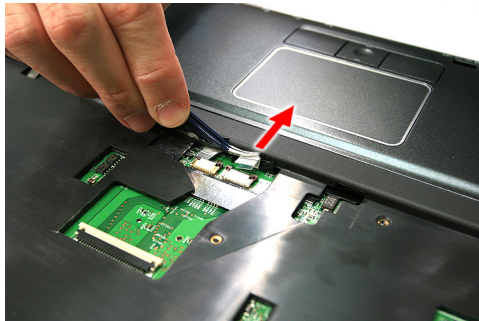
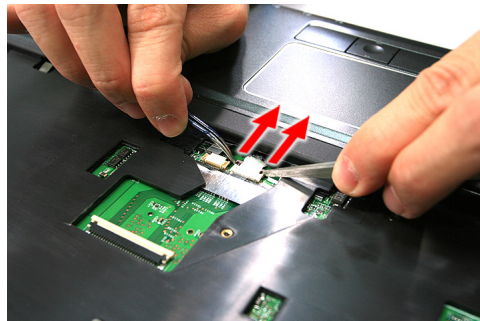



24. Remove the twenty screws (A) on the bottom and top panel.

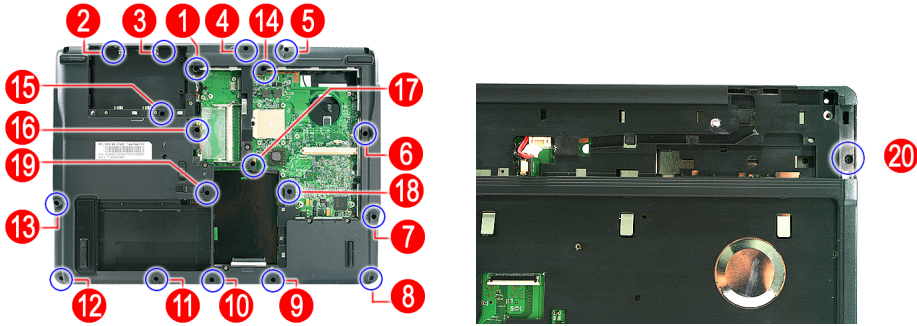

Step	Size (Quantity)	Color	Torque
1~20	M2.5 x L6 (20)	Black	3.0 kgf-cm

25. Gently pry the upper case from the main unit.

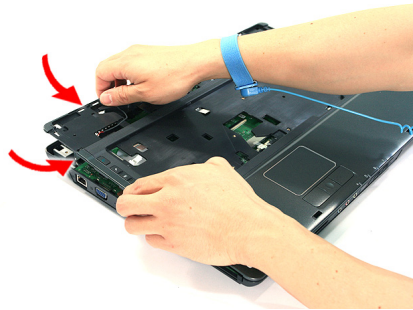

26. Remove the upper case from the main unit.

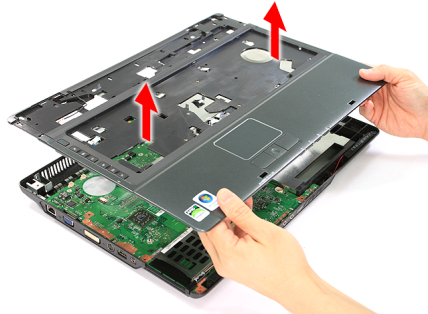

## Removing the Launch Board

1. See "Removing the Battery Pack" on page 62.
2. See "Removing the SD dummy card" on page 63.
3. See "Removing the PC and ExpressCard dummy cards" on page 63.
4. See "Removing the Lower Cover" on page 64.
5. See "Removing the Secondary HDD Cover" on page 65.
6. See "Removing the Secondary HDD Bracket and Connector" on page 66.
7. See "Removing the DIMM" on page 68.
8. See "Removing the WLAN Board Modules" on page 68.
9. See "Removing the Hard Disk Drive Module" on page 69.
10. See "Removing the Optical Drive Module" on page 70.
11. See "Removing the Modem Board" on page 73.

12. See “Removing the Heatsink Fan Module” on page 74.
13. See “Removing the CPU and VGA Heatsink Module” on page 75.
14. See “Removing the CPU” on page 76.
15. See “Removing the VGA board (for Discrete model only)” on page 77.
16. See “Removing the Middle Cover and the Power Board” on page 78.
17. See “Removing the Keyboard” on page 79.
18. See “Removing the LCD Module” on page 81.
19. See “Separating the Upper Case from the Lower Case” on page 83.
20. Remove the one screw (J) holding the launch board and remove the launch board from the upper cover.

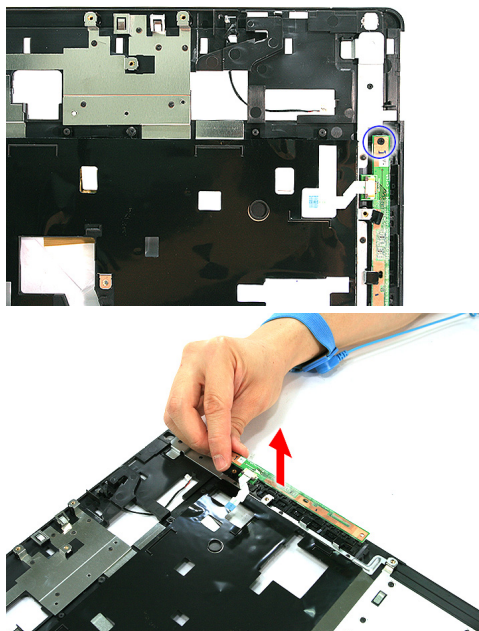

Step	Size (Quantity)	Color	Torque
1	M2 x L4 (1)	Black	1.6 kgf-cm

## Removing the Touch Pad Board Module

1. See “Removing the Battery Pack” on page 62.
2. See “Removing the SD dummy card” on page 63.
3. See “Removing the PC and ExpressCard dummy cards” on page 63.
4. See “Removing the Lower Cover” on page 64.
5. See “Removing the Secondary HDD Cover” on page 65.
6. See “Removing the Secondary HDD Bracket and Connector” on page 66.
7. See “Removing the DIMM” on page 68.
8. See “Removing the WLAN Board Modules” on page 68.
9. See “Removing the Hard Disk Drive Module” on page 69.
10. See “Removing the Optical Drive Module” on page 70.
11. See “Removing the Modem Board” on page 73.
12. See “Removing the Heatsink Fan Module” on page 74.
13. See “Removing the CPU and VGA Heatsink Module” on page 75.

14. See “Removing the CPU” on page 76.
15. See “Removing the VGA board (for Discrete model only)” on page 77.
16. See “Removing the Middle Cover and the Power Board” on page 78.
17. See “Removing the Keyboard” on page 79.
18. See “Removing the LCD Module” on page 81.
19. See “Separating the Upper Case from the Lower Case” on page 83.
20. Remove the fingerprint cable from the fingerprint board.

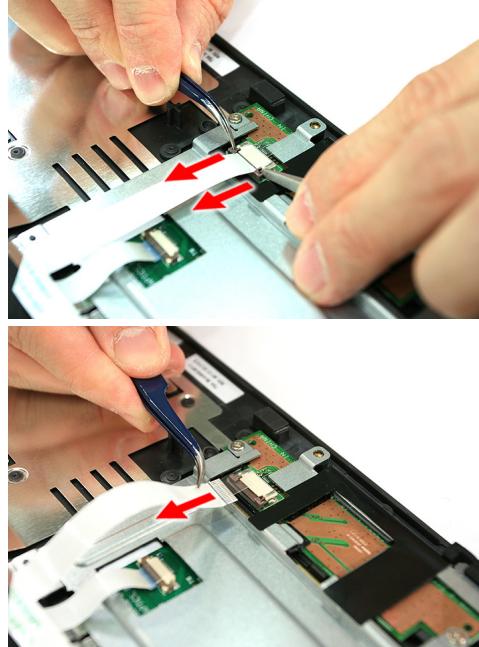

21. Remove the touch pad cable from the touch pad board.

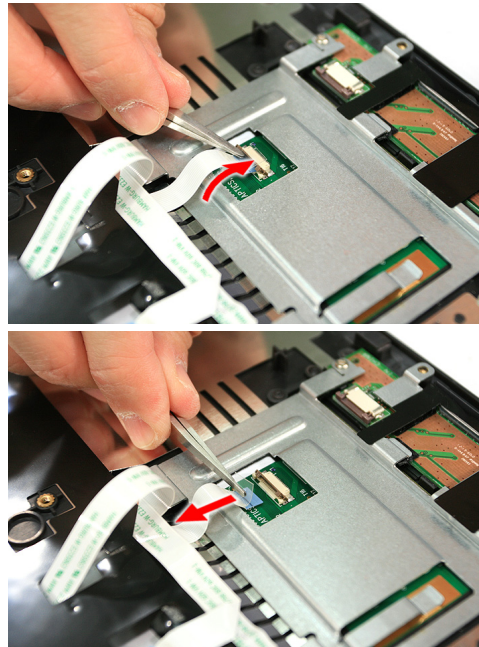

22. Remove the four screws (C) on the touch pad bracket and remove the touch pad bracket from the upper case.

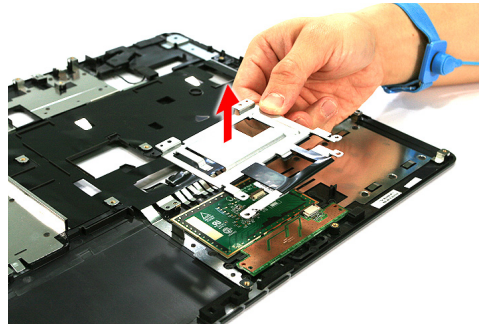
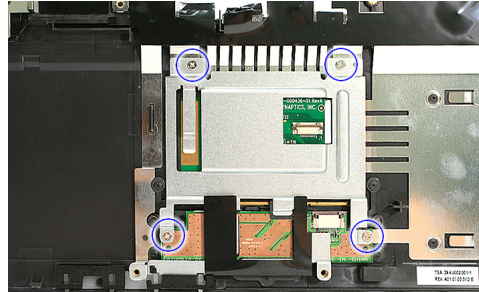

Step	Size (Quantity)	Color	Torque
1~4	M2 x L4 (4)	Silver	1.6 kgf-cm

23. Remove the fingerprint board from the upper case.

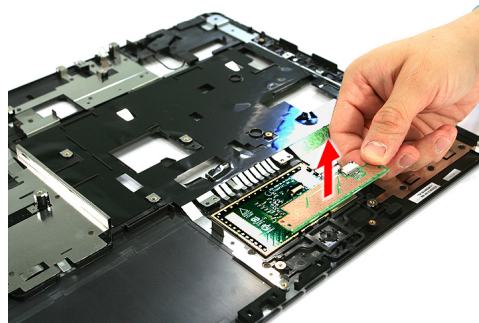



- 
24. Carefully pry loose and remove the touch pad board.

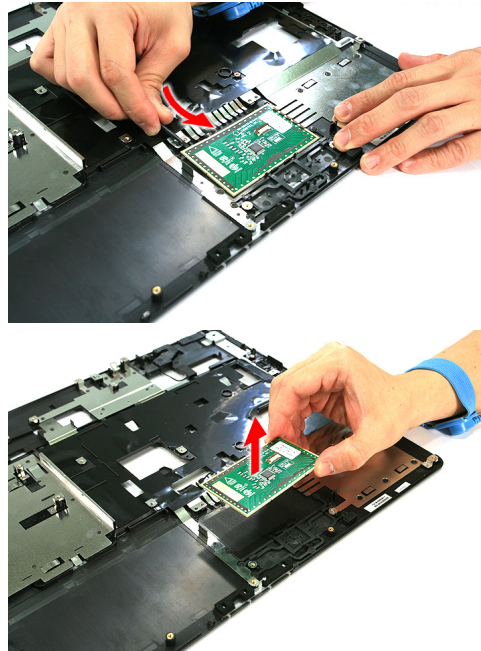

**WARNING:**The touchpad board is glued to the upper case, only remove the touchpad board if it is defective.

## Removing the Main Board

1. See “Removing the Battery Pack” on page 62.
2. See “Removing the SD dummy card” on page 63.
3. See “Removing the PC and ExpressCard dummy cards” on page 63.
4. See “Removing the Lower Cover” on page 64.
5. See “Removing the Secondary HDD Cover” on page 65.
6. See “Removing the Secondary HDD Bracket and Connector” on page 66.
7. See “Removing the DIMM” on page 68.
8. See “Removing the WLAN Board Modules” on page 68.
9. See “Removing the Hard Disk Drive Module” on page 69.
10. See “Removing the Optical Drive Module” on page 70.
11. See “Removing the Modem Board” on page 73.
12. See “Removing the Heatsink Fan Module” on page 74.
13. See “Removing the CPU and VGA Heatsink Module” on page 75.
14. See “Removing the CPU” on page 76.
15. See “Removing the VGA board (for Discrete model only)” on page 77.
16. See “Removing the Middle Cover and the Power Board” on page 78.
17. See “Removing the Keyboard” on page 79.
18. See “Removing the LCD Module” on page 81.
19. See “Separating the Upper Case from the Lower Case” on page 83.

20. Disconnect the USB cable from the main board.

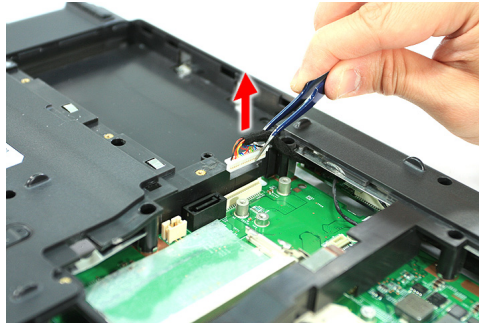

21. Disconnect the Bluetooth cable from the BLUE1 connector on the main board.

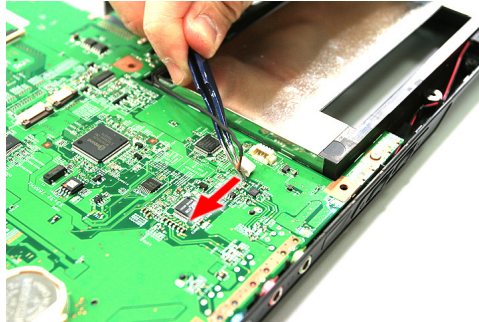

22. Disconnect the speaker cable from the SPKR1 on the main board.

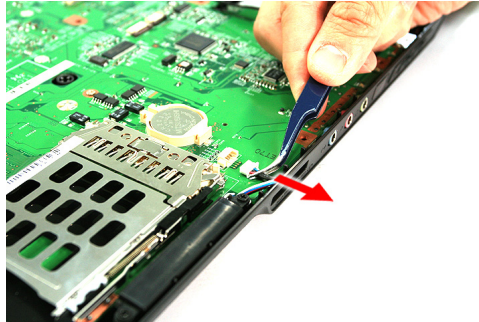

23. Remove the four screws (C) holding the main board.

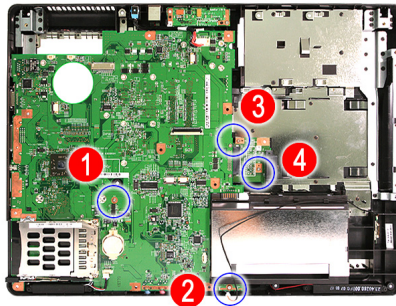

Step	Size (Quantity)	Color	Torque
1~4	M2 x L4 (4)	Silver	1.6 kgf-cm

24. Carefully remove the main board from the bottom panel.

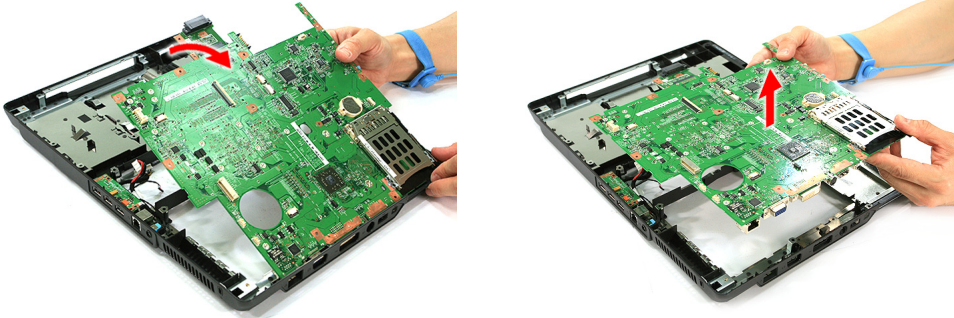

## Removing the ODD Board Module

1. See “Removing the Battery Pack” on page 62.
2. See “Removing the SD dummy card” on page 63.
3. See “Removing the PC and ExpressCard dummy cards” on page 63.
4. See “Removing the Lower Cover” on page 64.
5. See “Removing the Secondary HDD Cover” on page 65.
6. See “Removing the Secondary HDD Bracket and Connector” on page 66.
7. See “Removing the DIMM” on page 68.
8. See “Removing the WLAN Board Modules” on page 68.
9. See “Removing the Hard Disk Drive Module” on page 69.
10. See “Removing the Optical Drive Module” on page 70.
11. See “Removing the Modem Board” on page 73.
12. See “Removing the Heatsink Fan Module” on page 74.
13. See “Removing the CPU and VGA Heatsink Module” on page 75.
14. See “Removing the CPU” on page 76.
15. See “Removing the VGA board (for Discrete model only)” on page 77.
16. See “Removing the Middle Cover and the Power Board” on page 78.
17. See “Removing the Keyboard” on page 79.
18. See “Removing the LCD Module” on page 81.
19. See “Separating the Upper Case from the Lower Case” on page 83.
20. See “Removing the Main Board” on page 89.
21. Detach the ODD board module from the main board.

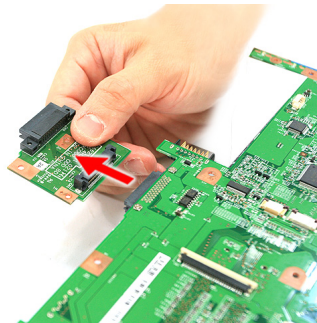

---

## Removing the Speaker Modules

1. See “Removing the Battery Pack” on page 62.
2. See “Removing the SD dummy card” on page 63.
3. See “Removing the PC and ExpressCard dummy cards” on page 63.
4. See “Removing the Lower Cover” on page 64.
5. See “Removing the Secondary HDD Cover” on page 65.
6. See “Removing the Secondary HDD Bracket and Connector” on page 66.
7. See “Removing the DIMM” on page 68.
8. See “Removing the WLAN Board Modules” on page 68.
9. See “Removing the Hard Disk Drive Module” on page 69.
10. See “Removing the Optical Drive Module” on page 70.
11. See “Removing the Modem Board” on page 73.
12. See “Removing the Heatsink Fan Module” on page 74.
13. See “Removing the CPU and VGA Heatsink Module” on page 75.
14. See “Removing the CPU” on page 76.
15. See “Removing the VGA board (for Discrete model only)” on page 77.
16. See “Removing the Middle Cover and the Power Board” on page 78.
17. See “Removing the Keyboard” on page 79.
18. See “Removing the LCD Module” on page 81.
19. See “Separating the Upper Case from the Lower Case” on page 83.
20. See “Removing the Main Board” on page 89.
21. Remove the tape securing the speaker cables in place.

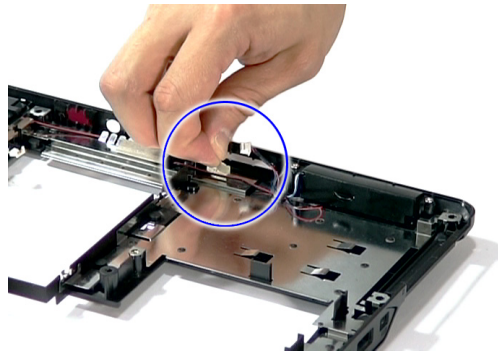

22. Release the speaker cables from the latches.

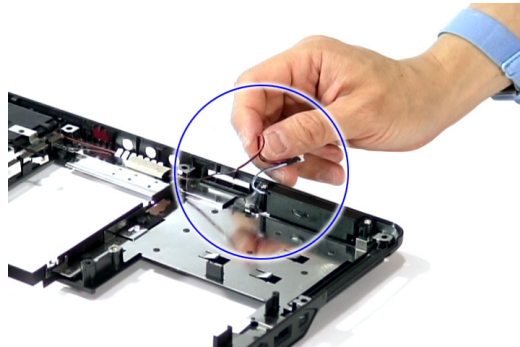



23. Remove the four screws (C) holding the left and right speakers.

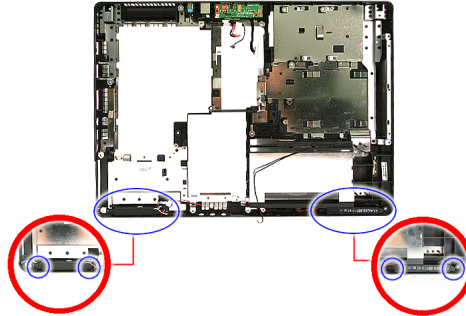

Step	Size (Quantity)	Color	Torque
1~4	M2 x L4 (4)	Silver	1.6 kgf-cm

24. Remove the left and right speakers from the upper case.

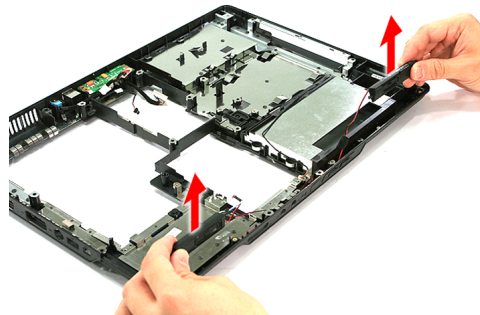

## Removing the USB Board

1. See "Removing the Battery Pack" on page 62.
2. See "Removing the SD dummy card" on page 63.
3. See "Removing the PC and ExpressCard dummy cards" on page 63.
4. See "Removing the Lower Cover" on page 64.
5. See "Removing the Secondary HDD Cover" on page 65.
6. See "Removing the Secondary HDD Bracket and Connector" on page 66.
7. See "Removing the DIMM" on page 68.
8. See "Removing the WLAN Board Modules" on page 68.
9. See "Removing the Hard Disk Drive Module" on page 69.
10. See "Removing the Optical Drive Module" on page 70.
11. See "Removing the Modem Board" on page 73.
12. See "Removing the Heatsink Fan Module" on page 74.
13. See "Removing the CPU and VGA Heatsink Module" on page 75.
14. See "Removing the CPU" on page 76.
15. See "Removing the VGA board (for Discrete model only)" on page 77.
16. See "Removing the Middle Cover and the Power Board" on page 78.
17. See "Removing the Keyboard" on page 79.
18. See "Removing the LCD Module" on page 81.
19. See "Separating the Upper Case from the Lower Case" on page 83.
20. See "Removing the Main Board" on page 89.

21. Remove the one screw (C) securing the USB board to the lower case.

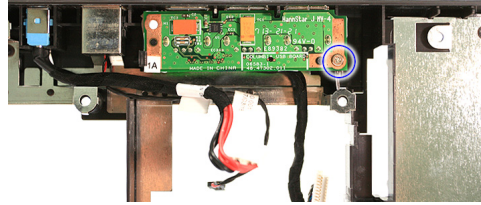

Step	Size (Quantity)	Color	Torque
1	M2 x L4 (1)	Silver	1.6 kgf-cm

22. Remove the USB Board from the lower case.

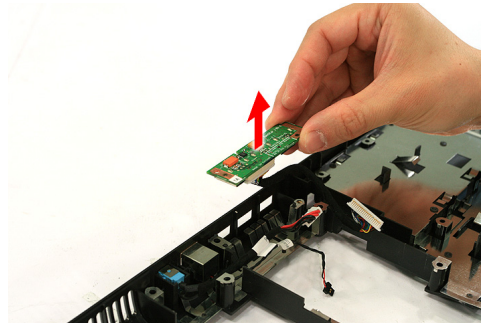

# LCD Module Disassembly Process

## LCD Module Disassembly Flowchart

### LCD MODULE DISASSEMBLY

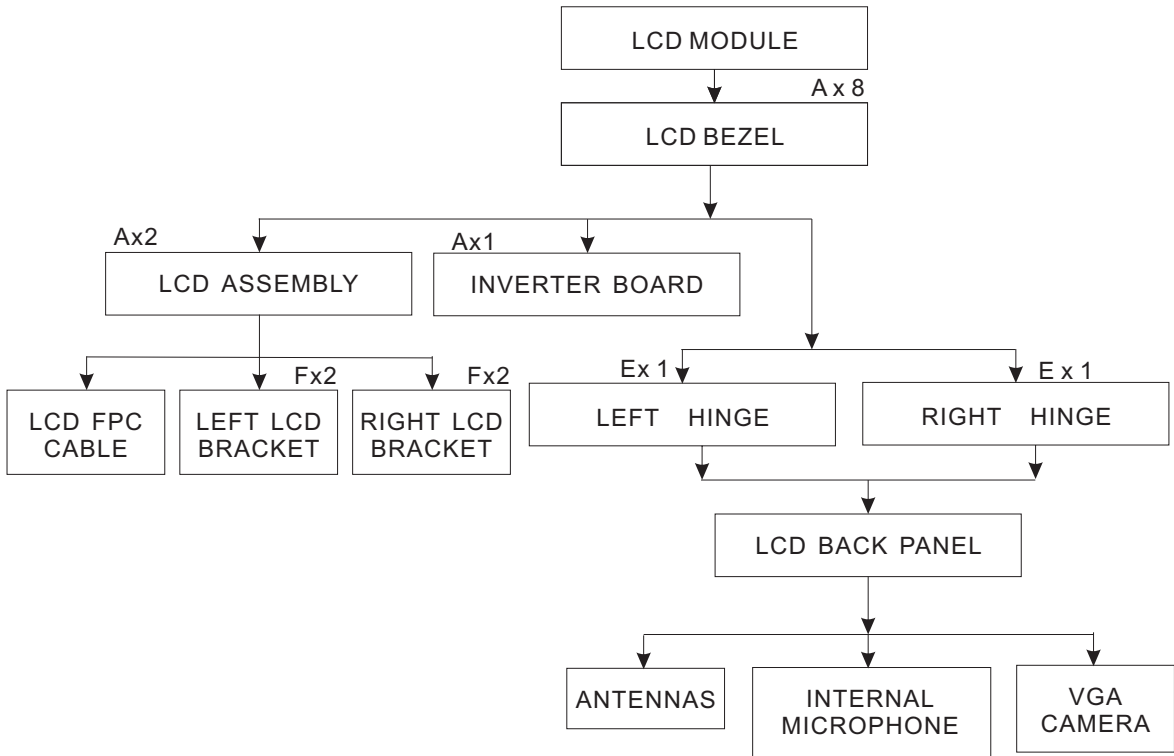

## Main Screw List

Item	Screw	Part No.
A	M2.5 x L6	86.00E33.736
E	M2.5 x L5	86.00F19.735
F	M2 x L3	86.00C07.220

# Removing the LCD Bezel

1. See “Removing the Battery Pack” on page 62.
2. See “Removing the Lower Cover” on page 64.
3. See “Removing the WLAN Board Modules” on page 68.
4. See “Removing the Middle Cover and the Power Board” on page 78.
5. See “Removing the LCD Module” on page 81.
6. Remove the four upper bezel screw caps and the four lower bezel caps.



7. Remove the eight screws (A) on the LCD module in the order as shown.



Step	Size (Quantity)	Color	Torque
1~8	M2.5 x L6 (8)	Black	3.0 kgf-cm

- Carefully pry open the LCD bezel and remove the bezel from the LCD module.

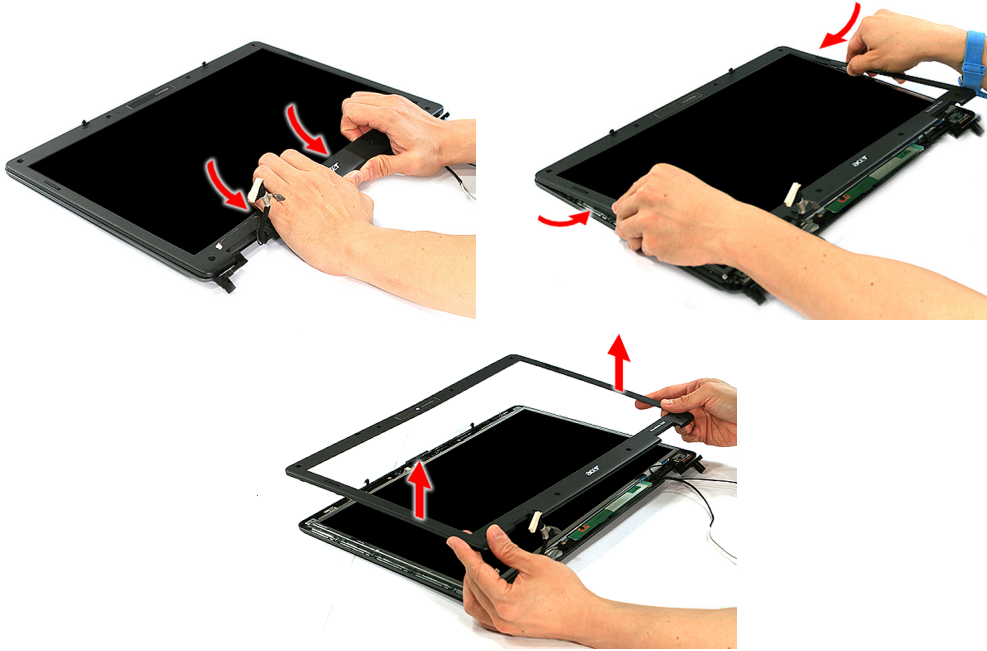

**NOTE:** The bottom side of the bezel is glued to the lcd panel, be careful when trying to remove the bezel.

## Removing the LCD module with the Brackets

- See “Removing the Battery Pack” on page 62.
- See “Removing the Lower Cover” on page 64.
- See “Removing the WLAN Board Modules” on page 68.
- See “Removing the Middle Cover and the Power Board” on page 78.
- See “Removing the LCD Module” on page 81.
- See “Removing the LCD Bezel” on page 96.
- Disconnect the cable from the camera board.

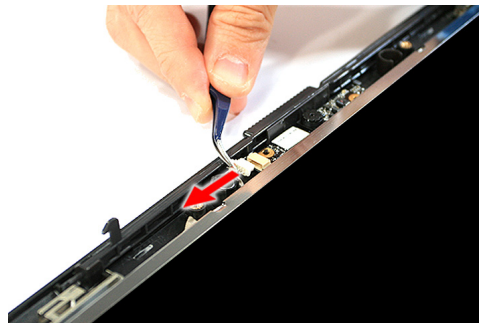

- Remove the three screws (A) securing the LCD module and the Inverter panel.

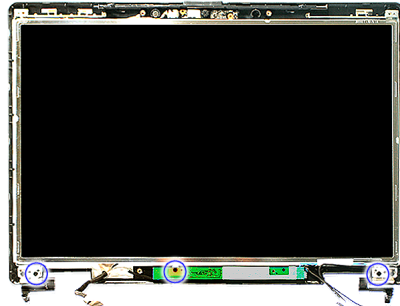

Step	Size (Quantity)	Color	Torque
1~3	M2.5 x L6 (3)	Black	3.0 kgf-cm

- Detach the LCD with the brackets from the back cover.

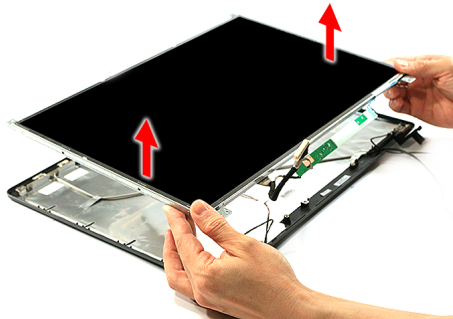

## Removing the Inverter Board and FPC Cable

- See “Removing the Battery Pack” on page 62.
- See “Removing the Lower Cover” on page 64.
- See “Removing the WLAN Board Modules” on page 68.
- See “Removing the Middle Cover and the Power Board” on page 78.
- See “Removing the LCD Module” on page 81.
- See “Removing the LCD Bezel” on page 96.
- See “Removing the LCD module with the Brackets” on page 97.
- Disconnect the inverter board cable from its connector, then disconnect the 2P cable on the inverter board to remove it.

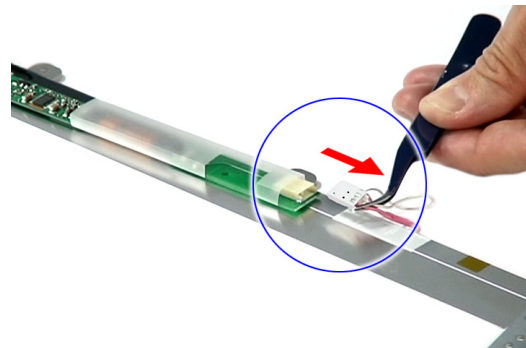
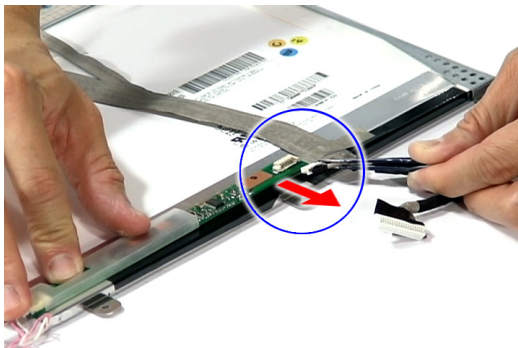

- Detach the acetic tapes holding the FPC cable from the LCD panel and detach the acetic tape securing the FPC connector.

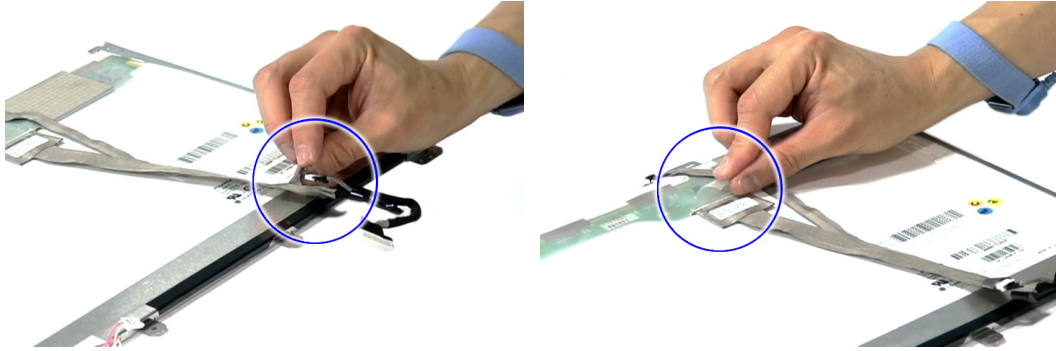

- Disconnect the FPC cable from the LCD panel.

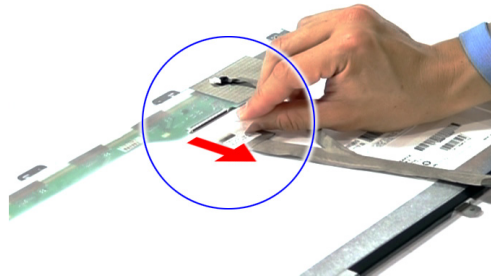

## Removing the LCD Brackets

- See “Removing the Battery Pack” on page 62.
- See “Removing the Lower Cover” on page 64.
- See “Removing the WLAN Board Modules” on page 68.
- See “Removing the Middle Cover and the Power Board” on page 78.
- See “Removing the LCD Module” on page 81.
- See “Removing the LCD Bezel” on page 96.
- See “Removing the LCD module with the Brackets” on page 97.
- See “Removing the Inverter Board and FPC Cable” on page 98.
- Remove the four screws (F) securing the left and right LCD brackets to remove the brackets.



Step	Size (Quantity)	Color	Torque
1~4	M2 x L3 (4)	Silver	1.6 kgf-cm

## Removing the Left and Right Hinge

1. See “Removing the Battery Pack” on page 62.
2. See “Removing the Lower Cover” on page 64.
3. See “Removing the WLAN Board Modules” on page 68.
4. See “Removing the Middle Cover and the Power Board” on page 78.
5. See “Removing the LCD Module” on page 81.
6. See “Removing the LCD Bezel” on page 96.
7. See “Removing the LCD module with the Brackets” on page 97.
8. Remove the two screws (E) securing the left and right hinge to the back cover.

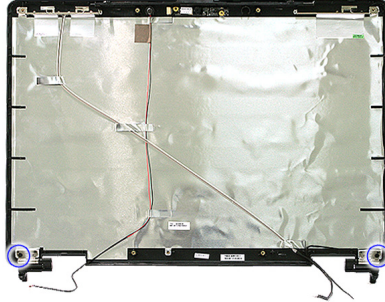

Step	Size (Quantity)	Color	Torque
1~2	M2.5 x L5 (2)	Black	2.5 kgf-cm

9. Remove the left and right hinge from the back cover.

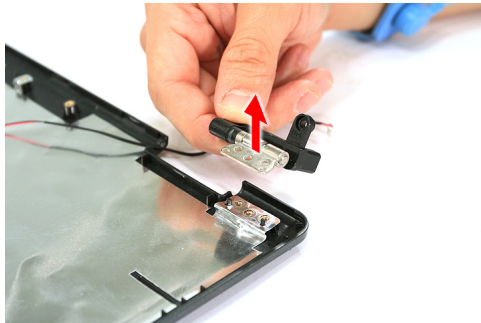

## Removing the Antennas

1. See “Removing the Battery Pack” on page 62.
2. See “Removing the Lower Cover” on page 64.
3. See “Removing the WLAN Board Modules” on page 68.
4. See “Removing the Middle Cover and the Power Board” on page 78.
5. See “Removing the LCD Module” on page 81.
6. See “Removing the LCD Bezel” on page 96.
7. See “Removing the LCD module with the Brackets” on page 97.
8. See “Removing the Left and Right Hinge” on page 100.



9. Loosen the aluminum tape holding the antennas in place.

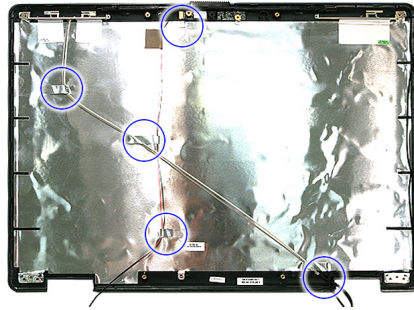

10. Release the antenna cables from the latches.

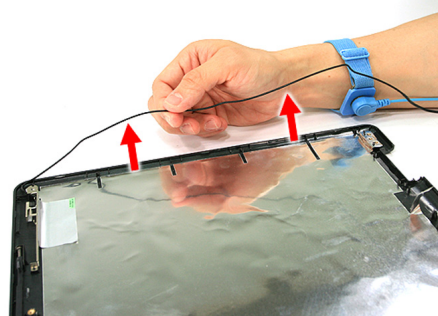

11. Remove the tapes together with the antenna cables from the back cover.

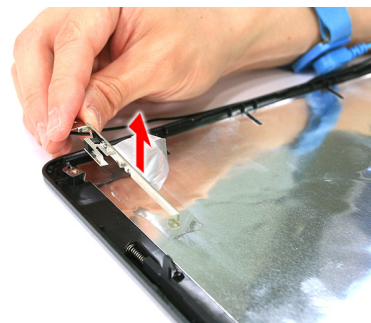
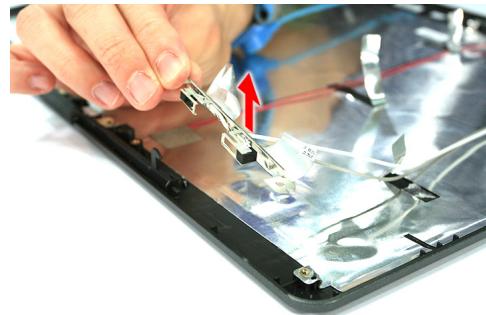

## Removing the Internal Microphone and Web Camera

1. See “Removing the Battery Pack” on page 62.
2. See “Removing the Lower Cover” on page 64.
3. See “Removing the WLAN Board Modules” on page 68.
4. See “Removing the Middle Cover and the Power Board” on page 78.
5. See “Removing the LCD Module” on page 81.
6. See “Removing the LCD Bezel” on page 96.

- 
7. See “Removing the LCD module with the Brackets” on page 97.
  8. See “Removing the Left and Right Hinge” on page 100.
  9. See “Removing the Antennas” on page 100.
  10. Remove the tape holding the internal microphone in place.

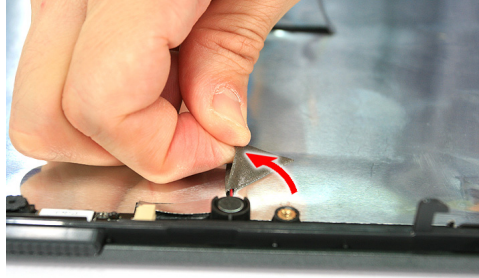

11. Remove the internal microphone from the back cover.

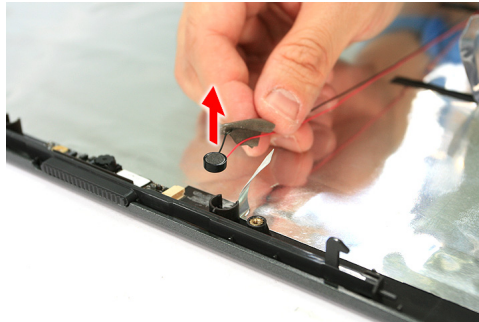

12. Remove the Web camera from the back cover.

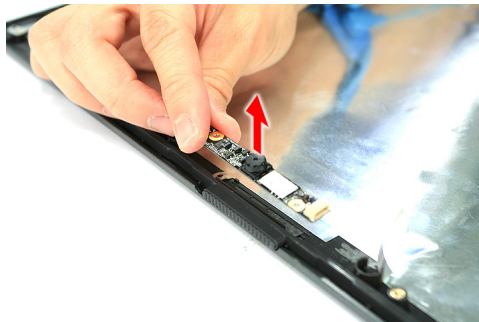

# Troubleshooting

Use the following procedure as a guide for computer problems.

**NOTE:** The diagnostic tests are intended to test only Acer products. Non-Acer products, prototype cards, or modified options can give false errors and invalid system responses.

1. Obtain the failing symptoms in as much detail as possible.
2. Verify the symptoms by attempting to re-create the failure by running the diagnostic test or by repeating the same operation.
3. Use the following table with the verified symptom to determine which page to go to.

Symptoms (Verified)	Go To
Power failure. (The power indicator does not go on or stay on.)	"Power System Check" on page 105.
POST does not complete. No beep or error codes are indicated.	"Power-On Self-Test (POST) Error Message" on page 108 "Undetermined Problems" on page 122
POST detects an error and displayed messages on screen.	"Error Message List" on page 109
Other symptoms (i.e. LCD display problems or others).	"Power-On Self-Test (POST) Error Message" on page 108
Symptoms cannot be re-created (intermittent problems).	Use the customer-reported symptoms and go to "Power-On Self-Test (POST) Error Message" on page 108 "Intermittent Problems" on page 121 "Undetermined Problems" on page 122

---

# System Check Procedures

## External Diskette Drive Check

Do the following to isolate the problem to a controller, driver, or diskette. A write-enabled, diagnostic diskette is required.

**NOTE:** Make sure that the diskette does not have more than one label attached to it. Multiple labels can cause damage to the drive or cause the drive to fail.

Do the following to select the test device.

1. Boot from the diagnostics diskette and start the diagnostics program.
2. See if FDD Test is passed as the program runs to FDD Test.
3. Follow the instructions in the message window.

If an error occurs with the internal diskette drive, reconnect the diskette connector on the system board.

If the error still remains:

1. Reconnect the external diskette drive/DVD-ROM module.
2. Replace the external diskette drive/CD-ROM module.
3. Replace the main board.

## External CD-ROM Drive Check

Do the following to isolate the problem to a controller, drive, or CD-ROM. Make sure that the CD-ROM does not have any label attached to it. The label can cause damage to the drive or can cause the drive to fail.

Do the following to select the test device:

1. Boot from the diagnostics diskette and start the diagnostics program.
2. See if CD-ROM Test is passed when the program runs to CD-ROM Test.
3. Follow the instructions in the message window.

If an error occurs, reconnect the connector on the System board. If the error still remains:

1. Reconnect the external diskette drive/CD-ROM module.
2. Replace the external diskette drive/CD-ROM module.
3. Replace the main board.

## Keyboard or Auxiliary Input Device Check

Remove the external keyboard if the internal keyboard is to be tested.

If the internal keyboard does not work or an unexpected character appears, make sure that the flexible cable extending from the keyboard is correctly seated in the connector on the system board.

If the keyboard cable connection is correct, run the Keyboard Test.

If the tests detect a keyboard problem, do the following one at a time to correct the problem. Do not replace a non-defective FRU:

1. Reconnect the keyboard cables.
2. Replace the keyboard.
3. Replace the main board.

The following auxiliary input devices are supported by this computer:

- Numeric keypad

- 
- External keyboard

If any of these devices do not work, reconnect the cable connector and repeat the failing operation.

## Memory check

Memory errors might stop system operations, show error messages on the screen, or hang the system.

1. Boot from the diagnostics diskette and start the doagmpstotics program (please refer to main board).
2. Go to the diagnostic memory in the test items.
3. Press F2 in the test items.
4. Follow the instructions in the message window.

**NOTE:** Make sure that the DIMM is fully installed into the connector. A loose connection can cause an error.

## Power System Check

To verify the symptom of the problem, power on the computer using each of the following power sources:

1. Remove the battery pack.
2. Connect the power adapter and check that power is supplied.
3. Disconnect the power adapter and install the charged battery pack; then check that power is supplied by the battery pack.

If you suspect a power problem, see the appropriate power supply check in the following list:

- "Check the Power Adapter" on page 106
- "Check the Battery Pack" on page 107

---

## Check the Power Adapter

Unplug the power adapter cable from the computer and measure the output voltage at the plug of the power adapter cable. See the following figure

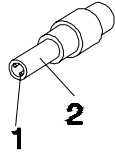

Pin 1: +19 to +20.5V

Pin 2: 0V, Ground

1. If the voltage is not correct, replace the power adapter.
2. If the voltage is within the range, do the following:
  - Replace the System board.
  - If the problem is not corrected, see “Undetermined Problems” on page 122.
  - If the voltage is not correct, go to the next step.

**NOTE:** An audible noise from the power adapter does not always indicate a defect.

3. If the power-on indicator does not light up, check the power cord of the power adapter for correct continuity and installation.
4. If the operational charge does not work, see “Check the Battery Pack” on page 107.

---

## Check the Battery Pack

To check the battery pack, do the following:

From Software:

1. Check out the Power Management in control Panel
2. In Power Meter, confirm that if the parameters shown in the screen for Current Power Source and Total Battery Power Remaining are correct.
3. Repeat the steps 1 and 2, for both battery and adapter.
4. This helps you identify first the problem is on recharging or discharging.

From Hardware:

1. Power off the computer.
2. Remove the battery pack and measure the voltage between battery terminals 1(+) and 6(ground).
3. If the voltage is still less than 7.5 Vdc after recharging, replace the battery.

To check the battery charge operation, use a discharged battery pack or a battery pack that has less than 50% of the total power remaining when installed in the computer.

If the battery status indicator does not light up, remove the battery pack and let it return to room temperature. Re-install the battery pack.

If the charge indicator still does not light up, replace the battery pack. If the charge indicator still does not light up, replace the DC/DC charger board.

## Touchpad Check

If the touchpad doesn't work, do the following actions one at a time to correct the problem. Do not replace a non-defective FRU:

1. Reconnect the touchpad cables.
2. Replace the touchpad.
3. Replace the system board.

After you use the touchpad, the pointer drifts on the screen for a short time. This self-acting pointer movement can occur when a slight, steady pressure is applied to the touchpad pointer. This symptom is not a hardware problem. No service actions are necessary if the pointer movement stops in a short period of time.

---

# Power-On Self-Test (POST) Error Message

The POST error message index lists the error message and their possible causes. The most likely cause is listed first.

**NOTE:** Perform the FRU replacement or actions in the sequence shown in FRU/Action column, if the FRU replacement does not solve the problem, put the original part back in the computer. Do not replace a non-defective FRU.

This index can also help you determine the next possible FRU to be replaced when servicing a computer.

If the symptom is not listed, see “Undetermined Problems” on page 122.

The following lists the error messages that the BIOS displays on the screen and the error symptoms classified by function.

**NOTE:** Most of the error messages occur during POST. Some of them display information about a hardware device, e.g., the amount of memory installed. Others may indicate a problem with a device, such as the way it has been configured.

**NOTE:** If the system fails after you make changes in the BIOS Setup Utility menus, reset the computer, enter Setup and install Setup defaults or correct the error.



# Index of Error Messages

## Error Code List

Error Codes	Error Messages
006	Equipment Configuration Error Causes: 1. CPU BIOS Update Code Mismatch 2. IDE Primary Channel Master Drive Error (The causes will be shown before "Equipment Configuration Error")
010	Memory Error at xxxx:xxxx:xxxxh (R:xxxxh, W:xxxxh)
070	Real Time Clock Error
071	CMOS Battery Bad
072	CMOS Checksum Error
110	System disabled. Incorrect password is specified.
<No error code>	Battery critical LOW In this situation BIOS will issue 4 short beeps then shut down system, no message will show.
<No error code>	Thermal critical High In this situation BIOS will shut down system, not show message.

## Error Message List

Error Messages	FRU/Action in Sequence
Failure Fixed Disk	Reconnect hard disk drive connector. "Load Default Settings" in BIOS Setup Utility. Hard disk drive System board
Stuck Key	see "Keyboard or Auxiliary Input Device Check" on page 104.
Keyboard error	see "Keyboard or Auxiliary Input Device Check" on page 104.
Keyboard Controller Failed	see "Keyboard or Auxiliary Input Device Check" on page 104.
Keyboard locked - Unlock key switch	Unlock external keyboard
Monitor type does not match CMOS - Run Setup	Run "Load Default Settings" in BIOS Setup Utility.
Shadow RAM Failed at offset: nnnn	BIOS ROM System board
System RAM Failed at offset: nnnn	DIMM System board
Extended RAM Failed at offset: nnnn	DIMM System board
System battery is dead - Replace and run Setup	Replace RTC battery and Run BIOS Setup Utility to reconfigure system time, then reboot system.
System CMOS checksum bad - Default configuration used	RTC battery Run BIOS Setup Utility to reconfigure system time, then reboot system.

## Error Message List

Error Messages	FRU/Action in Sequence
System timer error	RTC battery Run BIOS Setup Utility to reconfigure system time, then reboot system. System board
Real time clock error	RTC battery Run BIOS Setup Utility to reconfigure system time, then reboot system. System board
Previous boot incomplete - Default configuration used	Run "Load Default Settings" in BIOS Setup Utility. RTC battery System board
Memory size found by POST differed from CMOS	Run "Load Default Settings" in BIOS Setup Utility. DIMM System board
Diskette drive A error	Check the drive is defined with the proper diskette type in BIOS Setup Utility See "External Diskette Drive Check" on page 104.
Incorrect Drive A type - run SETUP	Check the drive is defined with the proper diskette type in BIOS Setup Utility
System cache error - Cache disabled	System board
CPU ID:	System board
DMA Test Failed	DIMM System board
Software NMI Failed	DIMM System board
Fail-Safe Timer NMI Failed	DIMM System board
Device Address Conflict	Run "Load Default Settings" in BIOS Setup Utility. RTC battery System board
Allocation Error for device	Run "Load Default Settings" in BIOS Setup Utility. RTC battery System board
Failing Bits: nnnn	DIMM BIOS ROM System board
Fixed Disk n	None
Invalid System Configuration Data	BIOS ROM System board
I/O device IRQ conflict	Run "Load Default Settings" in BIOS Setup Utility. RTC battery System board
Operating system not found	Enter Setup and see if fixed disk and drive A: are properly identified. Diskette drive Hard disk drive System board

## Error Message List

No beep Error Messages	FRU/Action in Sequence
No beep, power-on indicator turns off and LCD is blank.	Power source (battery pack and power adapter). See "Power System Check" on page 105.. Ensure every connector is connected tightly and correctly. Reconnect the DIMM. LED board. System board.
No beep, power-on indicator turns on and LCD is blank.	Power source (battery pack and power adapter). See "Power System Check" on page 105.. Reconnect the LCD connector Hard disk drive LCD inverter ID LCD cable LCD Inverter LCD System board
No beep, power-on indicator turns on and LCD is blank. But you can see POST on an external CRT.	Reconnect the LCD connectors. LCD inverter ID LCD cable LCD inverter LCD System board
No beep, power-on indicator turns on and a blinking cursor shown on LCD during POST.	Ensure every connector is connected tightly and correctly. System board
No beep during POST but system runs correctly.	Speaker System board

# Phoenix BIOS Beep Codes

Code	Beeps	POST Routine Description
02h		Verify Real Mode
03h		Disable Non-Maskable Interrupt (NMI)
04h		Get CPU type
06h		Initialize system hardware
08h		Initialize chipset with initial POST values
09h		Set IN POST flag
0Ah		Initialize CPU registers
0Bh		Enable CPU cache
0Ch		Initialize caches to initial POST values
0Eh		Initialize I/O component
0Fh		Initialize the local bus IDE
10h		Initialize Power Management
11h		Load alternate registers with initial POST values
12h		Restore CPU control word during warm boot
13h		Initialize PCI Bus Mastering devices
14h		Initialize keyboard controller
16h	1-2-2-3	BIOS ROM checksum
17h		Initialize cache before memory autosize
18h		8254 timer initialization
1Ah		8237 DMA controller initialization
1Ch		Reset Programmable Interrupt Controller
20h	1-3-1-1	Test DRAM refresh
22h	1-3-1-3	Test 8742 Keyboard Controller
24h		Set ES segment register to 4 GB
26h		Enable A20 line
28h		Autosize DRAM
29h		Initialize POST Memory Manager
2Ah		Clear 215 KB base RAM
2Ch	1-3-4-1	RAM failure on address line xxxx
2Eh	1-3-4-3	RAM failure on data bits xxxx of low byte of memory bus
2Fh		Enable cache before system BIOS shadow
30h	1-4-1-1	RAM failure on data bits xxxx of high byte of memory bus
32h		Test CPU bus-clock frequency
33h		Initialize Phoenix Dispatch Manager
36h		Warm start shut down
38h		Shadow system BIOS ROM
3Ah		Autosize cache

Code	Beeps	POST Routine Description
3Ch		Advanced configuration of chipset registers
3Dh		Load alternate registers with CMOS values
42h		Initialize interrupt vectors
45h		POST device initialization
46h	2-1-2-3	Check ROM copyright notice
48h		Check video configuration against CMOS
49h		Initialize PCI bus and devices
4Ah		Initialize all video adapters in system
4Bh		QuietBoot start (optional)
4Ch		Shadow video BIOS ROM
4Eh		Display BIOS copyright notice
50h		Display CPU type and speed
51h		Initialize EISA board
52h		Test keyboard
54h		Set key click if enabled
58h	2-2-3-1	Test for unexpected interrupts
59h		Initialize POST display service
5Ah		Display prompt "Press F2 to enter SETUP"
5Bh		Disable CPU cache
5Ch		Test RAM between 512 and 640 KB
60h		Test extended memory
62h		Test extended memory address lines
64h		Jump to User Patch1
66h		Configure advanced cache registers
67h		Initialize Multi Processor APIC
68h		Enable external and CPU caches
69h		Setup System Management Mode (SMM) area
6Ah		Display external L2 cache size
6Bh		Load custom defaults (optional)
6Ch		Display shadow-area message
6Eh		Display possible high address for UMB recovery
70h		Display error messages
72h		Check for configuration errors
76h		Check for keyboard errors
7Ch		Set up hardware interrupt vectors
7Eh		Initialize coprocessor if present
80h		Disable onboard Super I/O ports and IRQs
81h		Late POST device initialization

Code	Beeps	POST Routine Description
82h		Detect and install external RS232 ports
83h		Configure non-MCD IDE controllers
84h		Detect and install external parallel ports
85h		Initialize PC-compatible PnP ISA devices
86h		Re-initialize onboard I/O ports
87h		Configure Motherboard Configurable Devices (optional)
88h		Initialize BIOS Area
89h		Enable Non-Maskable Interrupts (NMIs)
8Ah		Initialize Extended BIOS Data Area
8Bh		Test and initialize PS/2 mouse
8Ch		Initialize floppy controller
8Fh		Determine number of ATA drives (optional)
90h		Initialize hard-disk controllers
91h		Initialize local-bus hard-disk controllers
92h		Jump to UserPatch2
93h		Build MPTABLE for multi-processor boards
95h		Install CD ROM for boot
96h		Clear huge ES segment register
97h		Fixup Multi Processor table
98h	1-2	Search for option ROMs. One long, two short beeps on checksum failure.
99h		Check for SMART drive (optional)
9Ah		Shadow option ROMs
9Ch		Set up Power Management
9Dh		Initialize security engine (optional)
9Eh		Enable hardware interrupts
9Fh		Determine number of ATA and SCSI drives
A0h		Set time of day
A2h		Check key lock
A4h		Initialize Typematic rate
A8h		Erase F2 prompt
AAh		Scan for F2 key stroke
ACh		Enter SETUP
A Eh		Clear Boot flag
B0h		Check for errors
B2h		POST done- prepare to boot operating system
B4h	1	One short beep before boot
B5h		Terminate QuietBoot (optional)
B6h		Check password (optional)

Code	Beeps	POST Routine Description
B9h		Prepare Boot
BAh		Initialize DMI parameters
BBh		Initialize PnP Option ROMs
BCh		Clear parity checkers
BDh		Display MultiBoot menu
BEh		Clear screen (optional)
BFh		Check virus and backup reminders
C0h		Try to boot with INT 19
C1h		Initialize POST Error Manager (PEM)
C2h		Initialize error logging
C3h		Initialize error display function
C4h		Initialize system error handler
C5h		PnPnd dual CMOS (optional)
C6h		Initialize notebook docking (optional)
C7h		Initialize notebook docking late
C8h		Force check (optional)
C9h		Extended checksum (optional)
D2h		Unknown interrupt

Code	Beeps	POST Routine Description
E0h		Initialize the chipset
E1h		Initialize the bridge
E2h		Initialize the CPU
E3h		Initialize the system timer
E4h		Initialize system I/O
E5h		Check force recovery boot
E6h		Checksum BIOS ROM
E7h		Go to BIOS
E8h		Set Huge Segment
E9h		Initialize Multi Processor
EAh		Initialize OEM special code
EBh		Initialize PIC and DMA
ECh		Initialize Memory type
EDh		Initialize Memory size
EEh		Shadow Boot Block
EFh		System memory test
F0h		Initialize interrupt vectors
F1h		Initialize Run Time Clock
F2h		Initialize video
F3h		Initialize System Management Mode
F4h	1	Output one beep before boot

---

Code	Beeps	
F5h		Boot to Mini DOS
F6h		Clear Huge Segment
F7h		Boot to Full DOS



# Index of Symptom-to-FRU Error Message

## LCD-Related Symptoms

Symptom / Error	Action in Sequence
LCD backlight doesn't work LCD is too dark LCD brightness cannot be adjusted LCD contrast cannot be adjusted	Enter BIOS Utility to execute "Load Setup Default Settings", then reboot system. Reconnect the LCD connectors. Keyboard (if contrast and brightness function key doesn't work). LCD inverter ID LCD cable LCD inverter LCD System board
Unreadable LCD screen Missing pels in characters Abnormal screen Wrong color displayed	Reconnect the LCD connector LCD inverter ID LCD cable LCD inverter LCD System board
LCD has extra horizontal or vertical lines displayed.	LCD inverter ID LCD inverter LCD cable LCD System board

## Indicator-Related Symptoms

Symptom / Error	Action in Sequence
Indicator incorrectly remains off or on, but system runs correctly	Reconnect the inverter board Inverter board System board

## Power-Related Symptoms

Symptom / Error	Action in Sequence
Power shuts down during operation	Power source (battery pack and power adapter). See "Power System Check" on page 105. Battery pack Power adapter Hard drive & battery connection board System board
The system doesn't power-on.	Power source (battery pack and power adapter). See "Power System Check" on page 105. Battery pack Power adapter Hard drive & battery connection board System board

### Power-Related Symptoms

Symptom / Error	Action in Sequence
The system doesn't power-off.	Power source (battery pack and power adapter). See "Power System Check" on page 105. Hold and press the power switch for more than 4 seconds. System board
Battery can't be charged	See "Check the Battery Pack" on page 107. Battery pack System board

### PCMCIA-Related Symptoms

Symptom / Error	Action in Sequence
System cannot detect the PC Card (PCMCIA)	PCMCIA slot assembly System board
PCMCIA slot pin is damaged.	PCMCIA slot assembly

### Memory-Related Symptoms

Symptom / Error	Action in Sequence
Memory count (size) appears different from actual size.	Enter BIOS Setup Utility to execute "Load Default Settings, then reboot system. DIMM System board

### Speaker-Related Symptoms

Symptom / Error	Action in Sequence
In Windows, multimedia programs, no sound comes from the computer.	Audio driver Speaker System board
Internal speakers make noise or emit no sound.	Speaker System board

### Power Management-Related Symptoms

Symptom / Error	Action in Sequence
The system will not enter hibernation	See "Save to Disk (S4)" on page 38. Keyboard (if control is from the keyboard) Hard disk drive System board
The system doesn't enter hibernation mode and four short beeps every minute.	Press Fn+0 and see if the computer enters hibernation mode. Touchpad Keyboard Hard disk connection board Hard disk drive System board
The system doesn't enter standby mode after closing the LCD	See "Save to Disk (S4)" on page 38. LCD cover switch System board

### Power Management-Related Symptoms

Symptom / Error	Action in Sequence
The system doesn't resume from hibernation mode.	See "Save to Disk (S4)" on page 38. Hard disk connection board Hard disk drive System board
The system doesn't resume from standby mode after opening the LCD.	See "Save to Disk (S4)" on page 38. LCD cover switch System board
Battery fuel gauge in Windows doesn't go higher than 90%.	Remove battery pack and let it cool for 2 hours. Refresh battery (continue use battery until power off, then charge battery). Battery pack System board
System hangs intermittently.	Reconnect hard disk/CD-ROM drives. Hard disk connection board System board

### Peripheral-Related Symptoms

Symptom / Error	Action in Sequence
System configuration does not match the installed devices.	Enter BIOS Setup Utility to execute "Load Default Settings", then reboot system. Reconnect hard disk/CD-ROM/diskette drives.
External display does not work correctly.	Press Fn+F5, LCD/CRT/Both display switching System board
USB does not work correctly	System board
Print problems.	Ensure the "Parallel Port" in the "Onboard Devices Configuration" of BIOS Setup Utility is set to Enabled. Onboard Devices Configuration Run printer self-test. Printer driver Printer cable Printer System Board
Serial or parallel port device problems.	Ensure the "Serial Port" in the Devices Configuration" of BIOS Setup Utility is set to Enabled. Device driver Device cable Device System board

### Keyboard/Touchpad-Related Symptoms

Symptom / Error	Action in Sequence
Keyboard (one or more keys) does not work.	Reconnect the keyboard cable. Keyboard System board

---

**Keyboard/Touchpad-Related Symptoms**

Symptom / Error	Action in Sequence
Touchpad does not work.	Reconnect touchpad cable. Touchpad board System board

**Modem-Related Symptoms**

Symptom / Error	Action in Sequence
Internal modem does not work correctly.	Modem phone port modem combo board System board

**NOTE:** If you cannot find a symptom or an error in this list and the problem remains, see “Undetermined Problems” on page 122.

---

# Intermittent Problems

Intermittent system hang problems can be caused by a variety of reasons that have nothing to do with a hardware defect, such as: cosmic radiation, electrostatic discharge, or software errors. FRU replacement should be considered only when a recurring problem exists.

When analyzing an intermittent problem, do the following:

1. Run the advanced diagnostic test for the system board in loop mode at least 10 times.
2. If no error is detected, do not replace any FRU.
3. If any error is detected, replace the FRU. Rerun the test to verify that there are no more errors.

---

# Undetermined Problems

The diagnostic problems does not identify which adapter or device failed, which installed devices are incorrect, whether a short circuit is suspected, or whether the system is inoperative.

Follow these procedures to isolate the failing FRU (do not isolate non-defective FRU).

**NOTE:** Verify that all attached devices are supported by the computer.

**NOTE:** Verify that the power supply being used at the time of the failure is operating correctly. (See "Power System Check" on page 105.):

1. Power-off the computer.
2. Visually check them for damage. If any problems are found, replace the FRU.
3. Remove or disconnect all of the following devices:
  - Non-Acer devices
  - Printer, mouse, and other external devices
  - Battery pack
  - Hard disk drive
  - DIMM
  - CD-ROM/Diskette drive Module
  - PC Cards
4. Power-on the computer.
5. Determine if the problem has changed.
6. If the problem does not recur, reconnect the removed devices one at a time until you find the failing FRU.
7. If the problem remains, replace the following FRU one at a time. Do not replace a non-defective FRU:
  - System board
  - LCD assembly

# Jumper and Connector Locations

## Top View

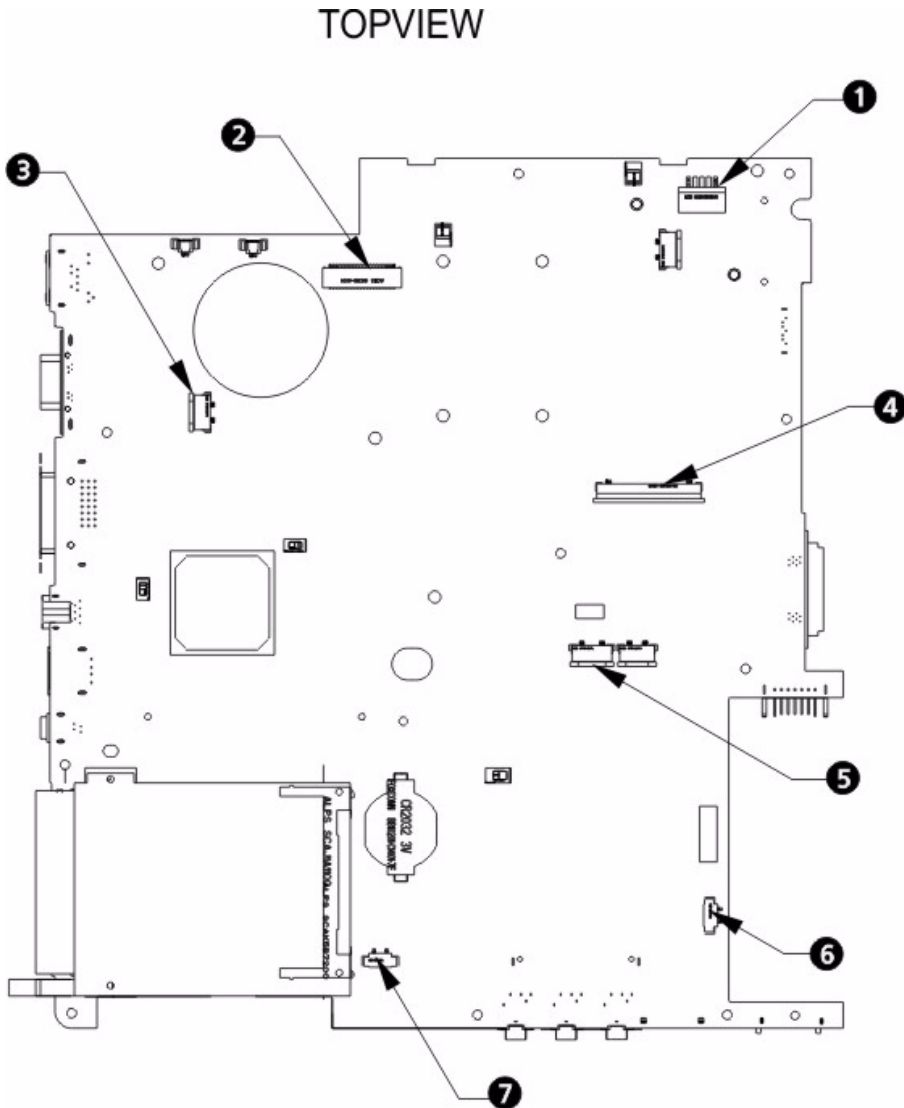

No.	Description	No.	Description
1	Power Cable Connector	5	Fingerprint/Touchpad Connector
2	LCD Cable Connector	6	Bluetooth Connector
3	Touchpad Board Connector	7	Speaker Connector
4	Keyboard Connector		

# Bottom View

## BOTTOMVIEW

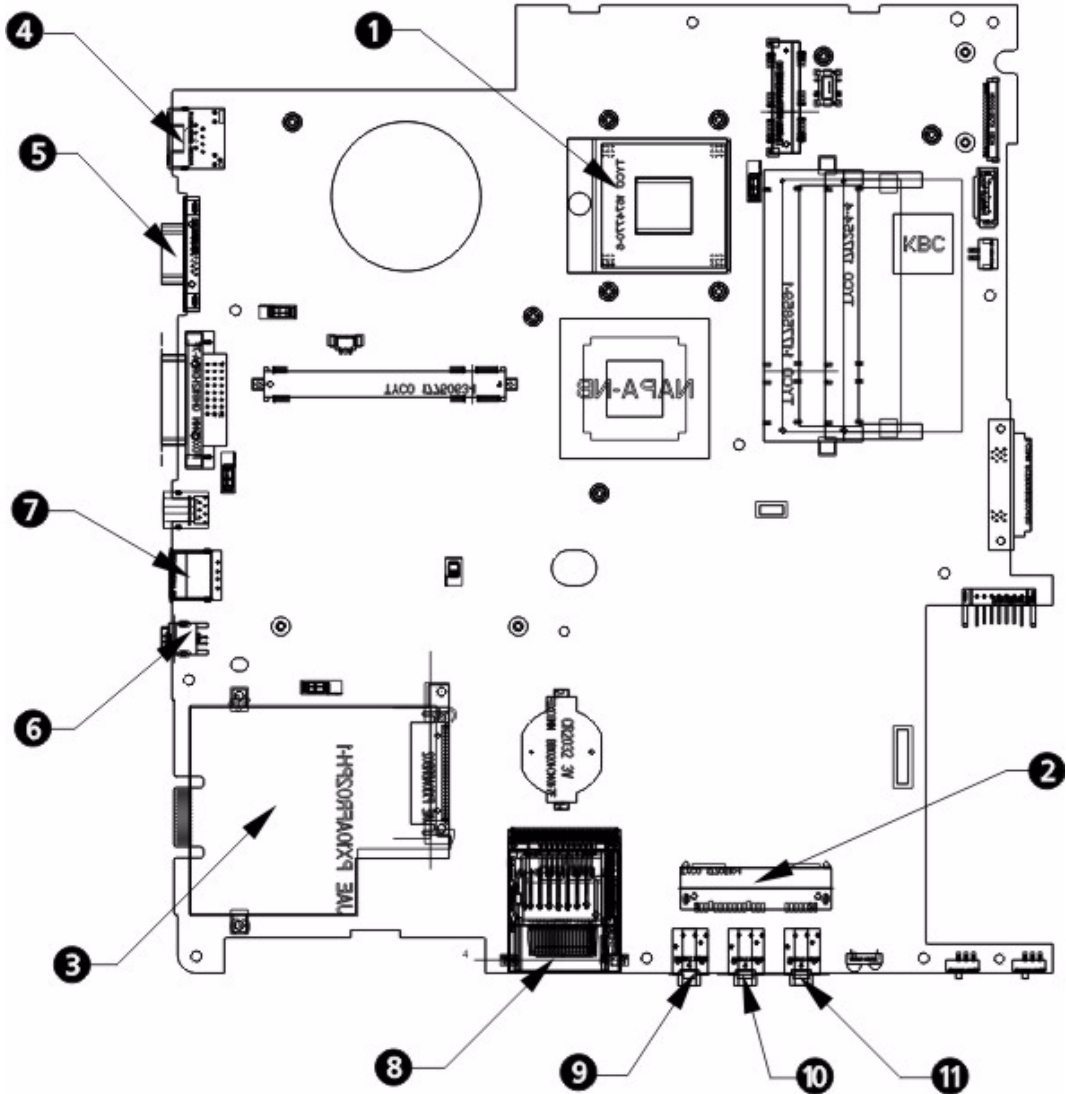

No.	Description	No.	Description
1	CPU	7	USB Connector
2	SATA Connector	8	Card Reader
3	PC Card Reader	9	Line-out jack
4	LAN Connector	10	Mic-in jack
5	CRT Connector	11	Headphone jack
6	1394 Connector		



---

## Standard Operation Procedures of Password Bypassing and BIOS Recovery

Bios/KBC update :

The firmware are combined into one binary file and support both DOS and Windows mode update

- DOS mode

DO make sure you have plugged in the AC adapter to prevent flashing failure.

Before flashing the BIOS, you should unzip the compressed file to one directory.

- a. Plug in the AC adapter.
- b. Unzip HIC100WW to C:\ HIC100WW.
- c. Boot to pure DOS.
- d. It is better not to load HIMEM.sys (bypass CONFIG.sys).
- e. To flash the BIOS by Phoenix flash utility, use "\*.wph" ROM file to update the BIOS via the following command: **C:\ HIC100WW \POM.BAT**

- Windows mode

DO make sure you have plugged in the AC adapter to prevent flashing failure.

Before flashing the BIOS, you should unzip the compressed file to one directory.

- a. Unzip HIC100WW to C:\ HIC100WW
- b. Plug in the AC adapter.
- c. Boot to pure Windows.
- d. To flash the BIOS by WFlash utility to update the BIOS via double click C:\ HIC100WW \Windows\ BIOSV1.00.exe

## Password Bypassing and Bios Recovery :

For RD and CSD to debug easily, TM5520/TM5220/EX5420/EX5120/TM7520/TM7220/EX7420/EX7120 provides one hardware PIN pad for Bypassing Password Check, and one Hotkey to enable BIOS Recovery.

1. PIN pad : To short PIN pad to bypass password check.
2. Hotkey to enable BIOS Recovery: Fn+ESC, then Power Button, AC+DC coexistence is strongly recommended.

**Bypassing Password Check :** If the user has set Password (power-on or setup password) for security reason, BIOS will check password during POST or when entering the BIOS setup menu. However, if it is necessary to ignore the password check, the user may enable short PIN Pad to bypass password check.

**BIOS Recovery:** Boot Block is a special block of BIOS. It is used to boot up the system with minimum BIOS initialization. The user can enable this feature to restore the BIOS to a successful one if previous BIOS flashing process fails.

---

## PIN pad Location

The system board provides one hardware Pin pad under the keyboard pad. RD/CSD can enable this function by shorting this pad. The Pin Pad location should look as the figure below.

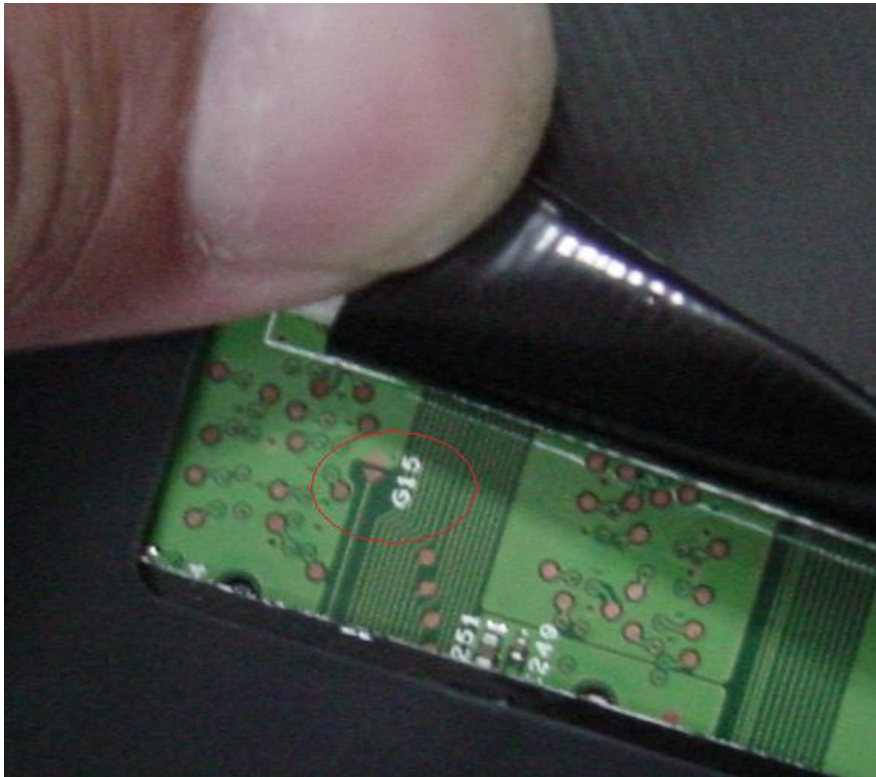

### 1. Clear Password

#### PIN Pad: Bypassing Password Check

Keep shorting the 2 triangle PIN pad as shown above and then powering on the system will force the BIOS to clear Supervisor and User passwords.

### 2. Clearing HDD password:

To decode HDD password error code for unlocking hard disk in a DOS environment.

```
A:\> unlock6 XXXXX 00
```

XXXXXX - HDD password error code

Unlock6.exe v1.1 2 May 2003

Choice what kind of the password to be generated:

0.) Exit

1.) Scan code

2.) upper case ASCII Code

3.) Lower case ASCII code

Enter your choice:2 (Choose 2)

XXXXXXXX

XXXXXXXX

XXXXXXXX

Those passwords are master password.

### 3. Restoring the BIOS through the Crisis Disk

---

Enable this function by pressing **Fn+ESC**, and the Power Button. To use this function, it is strongly recommended that the AC adapter is plugged and battery is inserted into the battery slot. If this function is enabled, the system will force the BIOS to enter into a special BIOS block, called BootBlock. RD/CSD can use this special BIOS code to recover the BIOS to a successful one if previous BIOS flashing process fails. However, before doing this, one Crisis Disk should be prepared in WinXP. Follow the steps below:

- a. Prepare the Crisis Disk in WinXP (Crisis Disk will be released when BIOS V1.00 is released)
- b. Insert the Crisis Disk to a USB floppy drive which is attached to the failed machine.
- c. On the power-off state, press Fn+ESC, hold them, then press the power button. The system should be powered on with Crisis Recovery process.
- d. BootBlock BIOS starts to restore the failed BIOS code. Short beeps should be heard when flashing.
- e. If the flashing process is finished, a long beep should be heard.
- f. Power down the system when the above steps is finished.

If the crisis recovery process is finished, the system should be powered on with a successful BIOS. RD/CSD can then update the BIOS to a workable one by regular BIOS flashing process.



## FRU (Field Replaceable Unit) List

---

This chapter gives you the FRU (Field Replaceable Unit) listing in global configurations of TravelMate 5710/5310 and Extensa 5610/5210. Refer to this chapter whenever ordering for parts to repair or for RMA (Return Merchandise Authorization).

Please note that WHEN ORDERING FRU PARTS, you should check the most up-to-date information available on your regional web or channel. For whatever reasons a part number change is made, it will not be noted on the printed Service Guide. For ACER AUTHORIZED SERVICE PROVIDERS, your Acer office may have a DIFFERENT part number code from those given in the FRU list of this printed Service Guide. You MUST use the local FRU list provided by your regional Acer office to order FRU parts for repair and service of customer machines.

NOTE: To scrap or to return the defective parts, you should follow the local government ordinance or regulations on how to dispose it properly, or follow the rules set by your regional Acer office on how to return it.

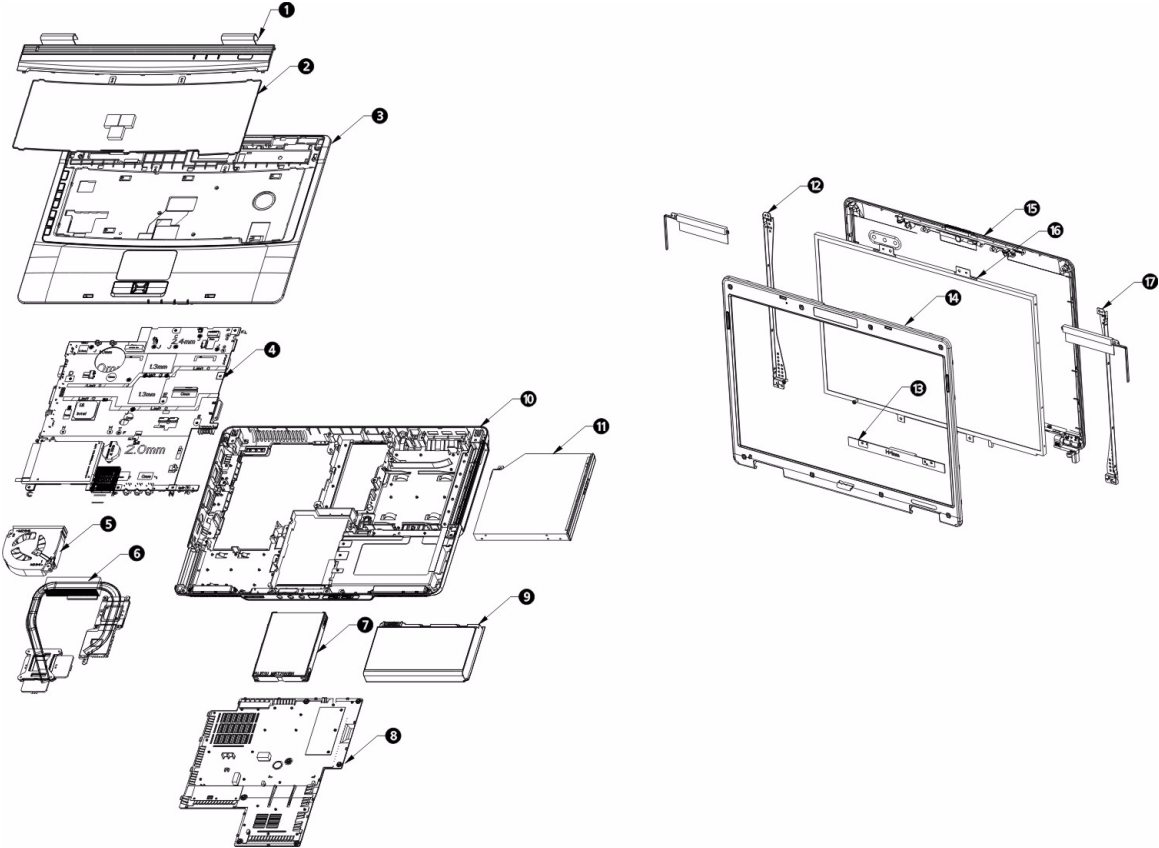

# TravelMate 7520/7520G/7220/7220G Exploded Diagram



## TravelMate 7520/7520G/7220/7220G FRU List

Category	No.	Part Name and Description	Acer Part No.
Adapter		ADAPTER 90W DELTA ADP-90SB BBDAR	AP.09001.010
		ADAPTER 90W DELTA ADP-90SB BBEA LF	AP.09001.013
		ADAPTER 90W LITEON PA-1900-04WR	AP.09003.005
		ADAPTER 90W LITEON PA-1900-24AR	AP.09003.011
Battery-			



Category	No.	Part Name and Description	Acer Part No.
		BATTERY PACK LI+ 6CELL 2.0MAH SANYO	BT.00603.029
		BATTERY PACK LI+ 6CELL 2.0MAH SONY	BT.00604.015
		BATTERY PACK LI 6CELL 2.0MAH PANASONIC	BT.00605.014
		BATTERY PACK LI 6CELL 2.0MAH SIMPLO	BT.00607.008
		BATTERY PACK LI+ 8CELL 2.4MAH SANYO	BT.00803.022
		BATTERY PACK LI+ 8CELL 2.4MAH SONY	BT.00804.019
		BATTERY PACK LI+ 8CELL 2.4MAH PANASONIC	BT.00805.010
		BATTERY PACK LI+ 8CELL 2.4MAH SIMPLO	BT.00807.013
		RTC BATTERY COIN BATTERY CR2032 MITSUBISHI	23.TCZV1.004
<b>Boards</b>			
		WIRELESS LAN BOARD 802.11ABG INTEL 3945 MW1	KI.GLN01.001
		WIRELESS LAN BOARD 802.11ABG INTEL 3945 MW2	KI.GLN01.002
		WIRELESS LAN BOARD 802.11ABG INTEL 3945 RW	KI.GLN01.003
		WIRELESS LAN BOARD 802.11ABG INTEL 3945BG	KI.GLN01.005
		WIRELESS LAN BOARD 802.11ABG KEDRON MOW1	KI.KDN01.001
		WIRELESS LAN BOARD 802.11ABG KEDRON MOW2	KI.KDN01.002
		WIRELESS LAN BOARD 802.11ABG KEDRON ROW	KI.KDN01.003
		VGA BOARD ATI MXM71 128MB GDDR HYNIX	55.TK801.001
		USB BOARD COLUMBIA 06583-1	55.TK901.001
		LAUNCH BOARD COLUMBIA 06584-1	55.TK901.002
		POWER BOARD COLUMBIA 06585-1M	55.TK901.003
		TOUCHPAD SCROLL-KEY BOARD COLUMBIA 06587-1	56.TKC01.001
		TOUCHPAD BOARD SYNAPTICS TM00372-012	56.TK901.001
		INVERTER BOARD 17" DARFON VK.21189.801	19.TK901.001
		INVERTER BOARD 17" FOXCONN T621249.00	19.TK901.002
		INVERTER BOARD 17" SUMIDA IV12151/T-LF	19.TK901.003
		INVERTER BOARD 17" YEC YNV-W10	19.TK901.004
		MODEM BOARD FOXCONN T60M955.00 3.3V	FX.22500.009

Category	No.	Part Name and Description	Acer Part No.
Cables			
		FINGER PRINT BOARD CABLE	50.TK901.001
		TOUCHPAD CABLE	50.TK901.002
		LAUNCH BOARD CABLE	50.TK901.003
		POWER BOARD CABLE	50.TK901.004
		BLUETOOTH CABLE	50.TK901.005
		MODEM CABLE	50.TK901.006
		USB BOARD CABLE	50.TK901.007
		DC-IN CABLE	50.TK901.008
		COVER SWITCH CABLE	50.TK901.009
		LCD CABLE 15.4"	50.TK901.011



Category	No.	Part Name and Description	Acer Part No.
		POWER CORD 10A 125V US	27.T30V1.001
		POWER CORD 10A 125V 3PIN US BK	27.01518.641
		POWER CORD 2.5A 125V 8121-USA/W CNS	27.01518.781
		POWER CORD 220V 3PIN EUR	27.T30V1.004
		POWER CABLE 16A 250V 3PIN EUR UK	27.01518.731
		POWER CORD 3A 250V 3PIN UK	27.01518.541
		POWER CORD 5A 250V 3PIN UK BK	27.03118.001
		POWER CORD 10A 3PIN BK DENMARK	27.01518.561
		POWER CORD 10A 250V 3PIN DENMARK BK	27.01518.671
		POWER CORD 10A 250V 3PIN BK SOUTH AFRICA	27.01518.571
		POWER CORD 16A 250V SOUTH AFRICA BK	27.01518.681
		POWER CORD 10A 250V SWISS	27.01518.581
		POWER CORD 10A 250V 3PIN SWISS BK	27.01518.691
		POWER CORD 10A 250V 3PIN CHINA	27.01518.591
		POWER CORD 10A 250V 3PIN CHINA BK	27.01518.701
		POWER CORD 10A 250V 3PIN ITALY	27.01518.611
		POWER CORD 10A 250V 3PIN ITALY BK	27.01518.711
		POWER CORD 2.5A 250V SOUTH AFRICA BK (INDIA)	27.01518.631
		POWER CORD 10A 250V SOUTH AFRICA BK (INDIA)	27.01518.721
		POWER CORD 2.5A 250V AUSTRALIA	27.01518.621
		POWER CORD ACA/ACNZ	27.03218.021
		POWER CORD 7A 125V 2PIN JAPEN	27.01518.551
		POWER CORD 7A 125V 2PIN JAPAN	27.03518.161
		POWER CORD 7A 250V 2PIN KOREA	27.01518.531
		POWER CORD 250V 10A 3PIN ISRAEL	27.01518.761
Case/Cover/Bracket/Assembly			
		VGA BOARD BRACKET MXM BRACKET ASSEMBLY	33.TK801.001
		TOUCH PAD BRACKET ASSEMBLY	33.TK901.001
		PCMCIA DUMMY CARD	42.TB1V1.003
		MIDDLE COVER ASSEMBLY	42.TK901.001
		NEW CARD DUMMY CARD	42.TK901.005
		SD DUMMY CARD	42.TK901.006
		LOWER CASE W/SPEAKER W/O FIR & DVI	60.TKC01.001

Category	No.	Part Name and Description	Acer Part No.
		UPPER CASE W/ COVER SWITCH CABLE	60.TKC01.002
		UNIT LOAD COVER L-CASE DOOR ASSEMBLY	60.TK901.003
		OPTICAL BRACKET	33.TK901.002
		COMBO BEZEL	42.TK901.002
		DVD-RW BEZEL	42.TK501.002
		HDD BRACKET ASSEMBLY	33.TK901.003
		LCD BRACKET RIGHT	33.TK901.004
		LCD BRACKET LEFT	33.TK901.005
		LCD COVER 15.4" W/ HINGE & LOGO	60.TKC01.005
		LCD BEZEL 15.4" W/ LOGO FOR CCD	60.TK901.005
		HINGE PACK LEFT/RIGHT	6K.TK901.001
		SPEAKER	23.TK901.002
<b>Combo Module</b>			
		COMBO MODULE 24X	6M.TK901.001
		COMBO MODULE 24X SONY CRX880A LF W/O BEZEL	KO.0240E.005
		COMBO MODULE 24X PANASONIC UJDA-780 LF W/O BEZEL	KO.02407.028
<b>CPU/Processor</b>			
		CPU YONAH T2250 1.73GHZ INTEL	KC.22501.DDP
		CPU YONAH T2250 1.73GHZ/533 INTEL	KC.22501.DTP
		CPU YONAH T2350 1.86GHZ INTEL	KC.23501.DTP
		CPU YONAH T2450 2.0GHZ INTEL	KC.24501.DTP
		CPU MEROM T5200 1.6GHZ INTEL	KC.52001.DTP
		CPU MEROM T5300 1.73GHZ INTEL	KC.53001.DTP
		CPU MEROM T5500 1.66GHZ INTEL PGA B	KC.55001.DTP

Category	No.	Part Name and Description	Acer Part No.
		CPU MEROM T5500 1.66GHZ INTEL PGA	KC.55L01.DTP
		CPU MEROM T5600 1.83GHZ INTEL PGA B	KC.56001.DTP
		CPU MEROM T5600 1.83GHZ INTEL PGA	KC.56L01.DTP
		CPU MEROM T7200 2.0GHZ INTEL PGA B2	KC.72001.DTP
		CPU MEROM T7400 2.16GHZ INTEL PGA B	KC.74001.DTP
		CPU MEROM T7600 2.33GHZ INTEL	KC.76001.DTP
		CPU YONAH CEL-M 430 1.73GHZ INTEL PGA	KC.N0001.430
		CPU YONAH CEL-M430 1.73GHZ INTEL	KC.ND001.430
		CPU YONAH 440 1.86GHZ INTEL PGA D0	KC.ND001.440
		CPU MEROM CEL-M 520 1.63GHZ INTEL	KC.N0001.520
		CPU MEROM CEL-M 530 1.73GHZ INTEL	KC.N0001.530
DVD-RW Drive			
		ASSEMBLY SUPLER MULTI MODULE 8X	6M.TK901.002
DVD Module			
		DVD-RW DRIVE 8X S-MUTI PIONEERDVR-K17RS LF W/O BEZEL	KU.00805.038
		DVD-RW DRIVE 8X S-MULTI PANASONIC UJ-850UAA1-A LF W/O BEZEL	KU.00807.055
		DVD-RW DRIVE 8X S-MULTI PHILIPS DS-8A1P LF W/O BEZEL	KU.00809.010
		DVD-RW DRIVE 8X S-MULTI HLDS GSA-T20N LF W/O BEZEL	KU.0080D.027
Fan			
		15" FAN FORCECON	23.TK901.001
Heatsink			
		CPU HEATSINK W/SCREW W/O FAN	60.TKA01.002
HDD/Hard Disk Drive			

Category	No.	Part Name and Description	Acer Part No.
		HDD 80GB 5400RPM SATA SEAGATE ST980811AS VENUS LF	KH.08001.030
		HDD 80GB 5400RPM SATA HGST HTS541680J9SA00 SURUGA-B LF	KH.08007.021
		HDD 80GB 5400RPM SATA WD WD800BEVS-22RST0ML80 LF	KH.08008.033
		HDD 120GB 5400RPM SATA SEAGATE ST9120822AS VENUS LF	KH.12001.031
		HDD 120GB 5400RPM SATA HGST HTS541612J9SA00 SURUGA-B LF	KH.12007.010
		HDD 120GB 5400RPM SATA WD WD1200BEVS-22RST0 ML80 LF	KH.12008.018
		HDD 160GB 5400RPM SATA SEAGATE ST9160821AS VENUS LF	KH.16001.026
		HDD 160GB 5400RPM SATA HGST HTS541616J9SA00 SURUGA-B LF	KH.16007.011
		HDD 160GB 5400RPM SATA WD WD1600BEVS-22RST0 ML80 LF	KH.16008.019
<b>Keyboard</b>			
		KEYBOARD 14_15KB-EV2 88KS BLACK US INTERNATIONAL (BIG ERGO) DARFON	KB.INT00.002
		KEYBOARD 14_15KB-EV2 88KS BLACK US INTERNATIONAL HEBREW (BIG ERGO) DARFON	KB.INT00.003
		KEYBOARD 14_15KB-EV2 89KS BLACK UK (BIG ERGO) DARFON	KB.INT00.004
		KEYBOARD 14_15KB-EV2 89KS BLACK TURKISH (BIG ERGO) DARFON	KB.INT00.005
		KEYBOARD 14_15KB-EV2 88KS BLACK THAILAND (BIG ERGO) DARFON	KB.INT00.006
		KEYBOARD 14_15KB-EV2 89KS BLACK SWISS/G (BIG ERGO) DARFON	KB.INT00.007
		KEYBOARD 14_15KB-EV2 89KS BLACK SWEDISH (BIG ERGO) DARFON	KB.INT00.008
		KEYBOARD 14_15KB-EV2 89KS BLACK SPANISH (BIG ERGO) DARFON	KB.INT00.009
		KEYBOARD 14_15KB-EV2 89KS BLACK SLOVENIAN (BIG ERGO) DARFON	KB.INT00.010
		KEYBOARD 14_15KB-EV2 88KS BLACK RUSSIAN (BIG ERGO) DARFON	KB.INT00.013
		KEYBOARD 14_15KB-EV2 89KS BLACK PORTUGUESE (BIG ERGO) DARFON	KB.INT00.014
		KEYBOARD 14_15KB-EV2 89KS BLACK NORWEGIAN (BIG ERGO) DARFON	KB.INT00.016

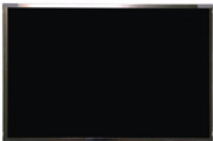
Category	No.	Part Name and Description	Acer Part No.
		KEYBOARD 14_15KB-EV2 88KS BLACK KOREAN (BIG ERGO) DARFON	KB.INT00.018
		KEYBOARD 14_15KB-EV2 93KS BLACK JAPANESE (BIG ERGO) DARFON	KB.INT00.019
		KEYBOARD 14_15KB-EV2 89KS BLACK ITALIAN (BIG ERGO) DARFON	KB.INT00.020
		KEYBOARD 14_15KB-EV2 89KS BLACK HUNGARIAN (BIG ERGO) DARFON	KB.INT00.023
		KEYBOARD 14_15KB-EV2 88KS BLACK GREEK (BIG ERGO) DARFON	KB.INT00.024
		KEYBOARD 14_15KB-EV2 89KS BLACK GERMAN (BIG ERGO) DARFON	KB.INT00.025
		KEYBOARD 14_15KB-EV2 89KS BLACK FRENCH (BIG ERGO) DARFON	KB.INT00.026
		KEYBOARD 14_15KB-EV2 89KS BLACK DANISH (BIG ERGO) DARFON	KB.INT00.029
		KEYBOARD 14_15KB-EV2 89KS BLACK CZECH (BIG ERGO) DARFON	KB.INT00.030
		KEYBOARD 14_15KB-EV2 88KS BLACK TRADITIONAL CHINESE (BIG ERGO) DARFON	KB.INT00.031
		KEYBOARD 14_15KB-EV2 89KS BLACK CANADIAN (BIG ERGO) DARFON	KB.INT00.032
		KEYBOARD 14_15KB-EV2 89KS BLACK BRAZILIAN PORTUGUESE (BIG ERGO) DARFON	KB.INT00.033
		KEYBOARD 14_15KB-EV2 89KS BLACK BELGIUM (BIG ERGO) DARFON	KB.INT00.034
		KEYBOARD 14_15KB-EV2 88KS BLACK ARABIC/ENGLISH (BIG ERGO) DARFON	KB.INT00.035
LCD Module			
		LCD MODULE 15.4" WXGA NONE GLARE W/ ANTENNA & 0.3M CAMERA	6M.TK101.001
		LCD 15.4" WXGA AU B154EW02-V0 NONE GLARE	LK.15405.013
		LCD 15.4" WXGA LG LP154WX4- TLA2 NONE GLARE	LK.15408.027
		LCD MODULE 15.4" WXGA GLARE W/ ANTENNA & 0.3M CAMERA	6M.TK101.002

Category	No.	Part Name and Description	Acer Part No.
		LCD 15.4" WXGA AU B154EW02-V1 GLARE	LK.15405.014
		LCD 15.4" WXGA LG LP154WX4- TLC2 GLARE	LK.15408.028
Camera			
		CAMERA CMOS 0.3M BISON BN30V4O717300 UVC	57.TK501.001
		CAMERA CMOS 0.3M SUYIN CN0314-OV03 UVC	57.TK901.001
		CAMERA COMOS 0.3M CHICONY CNF6041 UVC	57.TKC01.001
Communication Module			
		WIRELESS ANTENNA RIGHT	25.TK901.001
		WIRELESS ANTENNA LEFT	25.TK901.002
Microphone			
		MICROPHONE CABLE	23.TK901.003
Main Board			
		MAINBOARD TM5710 INTEL 945 PM ICH7M BCM578MKMLG LF W/ 1394 W/ MODEM & RTC BATTERY	MB.TK401.001
		MAINBOARD INTEL 943GML ICH7M NCM578MKMLG LF W/ 1394 W/ MODEM & RTC BATTERY	MBTK601.001
PCMCIA Slot/PC Card Slot			
		PCMCIA 4PIN SLOT CONN CARD BUS PX10AFR02PH-1	22.TK901.001
Memory			
		SDIMM 1GB DDRII667 SAMSUNG M470T2953EZ3-CE6	KN.1GB0B.011
		SDIMM 512MB DDRII667 NANYA NT512T64UH8B0FN-3C LF	KN.51203.032
		SDIMM 512MB DDRII667 SAMSUNG M470T6554EZ3-CE6 LF	KN.5120B.023
		SDIMM 512MB DDRII667 HYNIX HYMP564S64CP6-Y5AB LF	KN.5120G.019
		SDIMM 512MB DDRII667 PROMOS V916764B24QBFW-F5 LF	KN.5120M.004
		SDIMM 1GB DDRII667 NANYA NT1GT64U8HB0BN-3C LF	KN.1GB03.014
		SDIMM 1GB DDRII533 SAMSUNG M470T2953EZ3-CD5 LF	KN.1GB0B.012
		SDIMM 1GB DDRII667 HYNIX HYMP512S64CP8-Y5 LF	KN.1GB0G.006
		SDIMM 1GB DDRII667 PROMOS V916765G24QBFW-F5	KN.1GB0M.001
Miscellaneous			
		LOGO PLATE FOR PANEL	31.T49V1.001
		LOGO PLATE FOR BEZEL	31.A46V1.001
		NAME PLATE TM5710	40.TKC01.001

Category	No.	Part Name and Description	Acer Part No.
		NAME PLATE TM5310	40.TK601.001
		LCD SCREW RUBBER	47.TK501.001
Screws			
		SCREW M2 x L3 (WHITE)	86.00C07.220
		SCREW M2.5 x L6 NYLOK CR3+	86.00E33.736
		SCREW M2.5 x L8 NYLOK CR3+	86.00E34.738
		SCREW M2.5 x 5 NI	86.TK901.001
		SCREW MACH WAFER M3 x L4 NI	886.9A524.4R0
		SCREW M2.5 x L5 BLACK ZN+NYLOK	86.TK501.001
		SCREW DIMM COVER STEEL	86.00A02.140
		SCREW M2 x 4 WAFER NI	86.9A552.4R0
		SCREW NI M2 x L6	86.9A552.6R0

# Model Definition and Configuration

## TravelMate 7520/7520G/7220/7220G Series

Model	RO	Country	Acer Part no	Description	CPU	LCD	DIMM 1	DIMM 2	HDD 1 (GB)	ODD	Wireless LAN	Bluetooth	VOIP Phone
AS5051ANW XMi	AAP	India	LX.AV30C.002	AS5051AN WXM LINPUSIL1 UMAC 1*512/80/ 6L/5R/ CB_bg_0.3 C_AN	ATMK36	N14.1 WXGAG	SO512 MBII5	N	N80G B5.4K	NSM8 X	ABT_ATH54 13BG	N	N
AS5051ANW XMi	AAP	Indonesia	LX.AV30C.003	AS5051AN WXM LINPUSIN1 UMAC 1*512/80/ 6L/5R/ CB_bg_0.3 C_AN	ATMK36	N14.1 WXGAG	SO512 MBII5	N	N80G B5.4K	NSM8 X	ABT_ATH54 13BG	N	N
AS5051ANW XMi	AAP	Malaysia	LX.AV30C.005	AS5051AN WXM LINPUSMA2 UMAC 1*512/80/ 6L/5R/ CB_bg_0.3 C_AN	ATMK36	N14.1 WXGAG	SO512 MBII5	N	N80G B5.4K	NSM8 X	ABT_ATH54 13BG	N	N
AS5051ANW XMi	AAP	Philippines	LX.AV30C.004	AS5051AN WXM LINPUSPH1 UMAC 1*512/80/ 6L/5R/ CB_bg_0.3 C_AN	ATMK36	N14.1 WXGAG	SO512 MBII5	N	N80G B5.4K	NSM8 X	ABT_ATH54 13BG	N	N
AS5051ANW XMi	AAP	Singapore	LX.AV30C.001	AS5051AN WXM LINPUSSG1 UMAC 1*512/80/ 6L/5R/ CB_bg_0.3 C_AN	ATMK36	N14.1 WXGAG	SO512 MBII5	N	N80G B5.4K	NSM8 X	ABT_ATH54 13BG	N	N
AS5051ANW XMi	AAP	Thailand	LX.AV30C.006	AS5051AN WXM LINPUSTH2 UMAC 1*512/80/ 6L/5R/ CB_bg_0.3 C_AN	ATMK36	N14.1 WXGAG	SO512 MBII5	N	N80G B5.4K	NSM8 X	ABT_ATH54 13BG	N	N
AS5051ANW XMi	AAP	Vietnam	LX.AV30C.007	AS5051AN WXM LINPUSVN1 UMAC 1*512/80/ 6L/5R/ CB_bg_0.3 C_AN	ATMK36	N14.1 WXGAG	SO512 MBII5	N	N80G B5.4K	NSM8 X	ABT_ATH54 13BG	N	N



Model	RO	Country	Acer Part no	Description	CPU	LCD	DIMM 1	DIMM 2	HDD 1 (GB)	ODD	Wireless LAN	Bluetooth	VOIP Phone
AS5051AWX Mi	PA	USA/ Canada - Canadian French	LX.AV 30J.00 1	AS5051AW XMi MCECF UMAC 2*512/120/ 6L/5R/ CB_bg_0.3 C_AN	ATMK 36	N14.1 WXGA G	SO512 MBII5	SO512 MBII5	N120 GB5.4 K	NSM8 X	ABT_ATH54 13BG	N	N
AS5051AWX Mi	PA	USA/ Canada - Canadian French	LX.AV 30J.00 2	AS5051AW XMi MCEUS UMAC 2*512/120/ 6L/5R/ CB_bg_0.3 C_AN	ATMK 36	N14.1 WXGA G	SO512 MBII5	SO512 MBII5	N120 GB5.4 K	NSM8 X	ABT_ATH54 13BG	N	N
AS5051AWX Mi	AAP	Australia/ New Zealand	LX.AV 305.00 1	AS5051AW XMi XPHAU1 UMAC 1*512/120/ 6L/5R/ CB_bg_0.3 C_AN	ATMK 36	N14.1 WXGA G	SO512 MBII5	N	N120 GB5.4 K	NSM8 X	ABT_ATH54 13BG	N	N
AS5051AWX Mi	PA	USA/ Canada	LX.AV 305.00 8	AS5051AW XMi XPHEN1 UMAC 1*512/120/ 6L/5R/ CB_bg_0.3 C_AN	ATMK 36	N14.1 WXGA G	SO512 MBII5	N	N120 GB5.4 K	NSM8 X	ABT_ATH54 13BG	N	N
AS5051AWX Mi	PA	ACLA-Spanish	LX.AV 305.01 0	AS5051AW XMi XPHES1 UMAC 1*512/120/ 6L/5R/ CB_bg_0.3 C_AN	ATMK 36	N14.1 WXGA G	SO512 MBII5	N	N120 GB5.4 K	NSM8 X	ABT_ATH54 13BG	N	N
AS5051AWX Mi	PA	USA/ Canada	LX.AV 305.00 9	AS5051AW XMi XPHFR1 UMAC 1*512/120/ 6L/5R/ CB_bg_0.3 C_AN	ATMK 36	N14.1 WXGA G	SO512 MBII5	N	N120 GB5.4 K	NSM8 X	ABT_ATH54 13BG	N	N
AS5051AWX Mi	AAP	Indonesia	LX.AV 305.00 7	AS5051AW XMi XPHIN1 UMAC 1*512/120/ 6L/5R/ CB_bg_0.3 C_AN	ATMK 36	N14.1 WXGA G	SO512 MBII5	N	N120 GB5.4 K	NSM8 X	ABT_ATH54 13BG	N	N
AS5051AWX Mi	AAP	Malaysia	LX.AV 305.00 3	AS5051AW XMi XPHMA2 UMAC 1*512/120/ 6L/5R/ CB_bg_0.3 C_AN	ATMK 36	N14.1 WXGA G	SO512 MBII5	N	N120 GB5.4 K	NSM8 X	ABT_ATH54 13BG	N	N
AS5051AWX Mi	AAP	Philippines	LX.AV 305.00 2	AS5051AW XMi XPHPH1 UMAC 1*512/120/ 6L/5R/ CB_bg_0.3 C_AN	ATMK 36	N14.1 WXGA G	SO512 MBII5	N	N120 GB5.4 K	NSM8 X	ABT_ATH54 13BG	N	N

Model	RO	Country	Acer Part no	Description	CPU	LCD	DIMM 1	DIMM 2	HDD 1 (GB)	ODD	Wireless LAN	Bluetooth	VOIP Phone
AS5051AWX Mi	AAP	Thailand	LX.AV 305.004	AS5051AWXMi XPPTH2 UMAC 1*512/120/ 6L/5R/ CB_bg_0.3 C_AN	ATMK 36	N14.1 WXGAG	SO512 MBII5	N	N120 GB5.4 K	NSM8 X	ABT_ATH54 13BG	N	N
AS5051AWX Mi	AAP	Vietnam	LX.AV 305.005	AS5051AWXMi XPHVN1 UMAC 1*512/120/ 6L/5R/ CB_bg_0.3 C_AN	ATMK 36	N14.1 WXGAG	SO512 MBII5	N	N120 GB5.4 K	NSM8 X	ABT_ATH54 13BG	N	N
AS5051AWX Mi	AAP	Singapore	LX.AV 305.006	AS5051AWXMi XPHWSG2 1W UMAC 1*512/120/ 6L/5R/ CB_bg_0.3 C_AN	ATMK 36	N14.1 WXGAG	SO512 MBII5	N	N120 GB5.4 K	NSM8 X	ABT_ATH54 13BG	N	N
AS5051AWX Mi	PA	ACLA-Portuguese	LX.AV 305.011	AS5051AWXMi XPHXC1 UMAC 1*512/120/ 6L/5R/ CB_bg_0.3 C_AN	ATMK 36	N14.1 WXGAG	SO512 MBII5	N	N120 GB5.4 K	NSM8 X	ABT_ATH54 13BG	N	N
AS5051AWX Mi	TWN	GCTWN	S2.AV 305.001	AS5051AWXMi XPHTC1 UMAC 2*512/120/ BT/6L/5R/ CB_bg_0.3 C_AN	ATMK 36	N14.1 WXGAG	SO512 MBII6	SO512 MBII6	N120 GB5.4 K	NSM8 X	ABT_ATH54 13BG	FOX_BRM_2.0	N
AS5052WXM i	TWN	GCTWN	S2.AV 305.002	AS5052WXM i XPHTC1 UMAC 2*512/100/ BT/6L/5R/ CB_bg_0.3 C_AN	ATTL50	N14.1 WXGAG	SO512 MBII6	SO512 MBII6	N100 GB5.4 K	NSM8 X	ABT_ATH54 13BG	FOX_BRM_2.0	N
AS5055WXM i	TWN	GCTWN	S2.AV 305.003	AS5055WXM i XPHTC1 UMAC 2*1G/160/ BT/6L/5R/ CB_bg_0.3 C_AN	ATTL60	N14.1 WXGAG	SO1G BII5	SO1G BII5	N160 GB5.4 KS	NSM8 X	ABT_BRM4 318BG	FOX_BRM_2.0	N
AS5051AWX Ci	China	Hong Kong	LX.AV 305.016	AS5051AWXCi XPHHK9 UMAC 1*512/120/ 6L/5R/ CB_bg_0.3 C_AN	ATMK 36	N14.1 WXGAG	SO512 MBII5	N	N120 GB5.4 K	NCB2 4X	ABT_ATH54 13BG	N	N
AS5051AWX Ci	China	China	LX.AV 305.015	AS5051AWXCi XPHSC7 UMAC 1*512/120/ 6L/5R/ CB_bg_0.3 C_AN	ATMK 36	N14.1 WXGAG	SO512 MBII5	N	N120 GB5.4 K	NCB2 4X	ABT_ATH54 13BG	N	N

Model	RO	Country	Acer Part no	Description	CPU	LCD	DIMM 1	DIMM 2	HDD 1 (GB)	ODD	Wireless LAN	Bluetooth	VOIP Phone
AS5051AWX Mi	TWN	GCTWN	LX.AV 305.012	AS5051AW XMi XPHTC1 UMAC 1*512/120/ BT/6L/5R/ CB_bg_0.3 C_AN	ATMK 36	N14.1 WXGAG	SO512 MBII5	N	N120 GB5.4 K	NSM8 X	ABT_ATH54 13BG	FOX_BRM_2.0	N
AS5051AWX Mi	TWN	GCTWN	LX.AV 305.014	AS5051AW XMi XPHTC1 UMAC 1*512/60/ BT/6L/5R/ CB_bg_0.3 C_AN	ATMK 36	N14.1 WXGAG	SO512 MBII5	N	N60G B5.4K	NSM8 X	ABT_ATH54 13BG	FOX_BRM_2.0	N
AS5051AWX Mi	TWN	GCTWN	LX.AV 305.013	AS5051AW XMi XPHTC1 UMAC 1*512/80/ BT/6L/5R/ CB_bg_0.3 C_AN	ATMK 36	N14.1 WXGAG	SO512 MBII5	N	N80G B5.4K	NSM8 X	ABT_ATH54 13BG	FOX_BRM_2.0	N
AS5051AWX Mi	AAP	Australia/ New Zealand	LX.AV 30J.011	AS5051AW XMi MCEAU1 UMAC 1*1G/120/ 6L/5R/ CB_bg_0.3 C_AN	ATMK 36	N14.1 WXGAG	SO1G BII6	N	N120 GB5.4 K	NSM8 X	ABT_ATH54 13BG	N	N
AS5051AWX Mi	AAP	Singapore	LX.AV 30J.012	AS5051AW XMi MCESG1 UMAC 1*1G/120/ 6L/5R/ CB_bg_0.3 C_AN	ATMK 36	N14.1 WXGAG	SO1G BII6	N	N120 GB5.4 K	NSM8 X	ABT_ATH54 13BG	N	N
AS5051AWX Mi	AAP	India	LX.AV 30J.013	AS5051AW XMi MCEIL1 UMAC 1*1G/120/ 6L/5R/ CB_bg_0.3 C_AN	ATMK 36	N14.1 WXGAG	SO1G BII6	N	N120 GB5.4 K	NSM8 X	ABT_ATH54 13BG	N	N
AS5051AWX Mi	AAP	Indonesia	LX.AV 30J.014	AS5051AW XMi MCEIN1 UMAC 1*1G/120/ 6L/5R/ CB_bg_0.3 C_AN	ATMK 36	N14.1 WXGAG	SO1G BII6	N	N120 GB5.4 K	NSM8 X	ABT_ATH54 13BG	N	N
AS5051AWX Mi	AAP	Philippines	LX.AV 30J.015	AS5051AW XMi MCEPH1 UMAC 1*1G/120/ 6L/5R/ CB_bg_0.3 C_AN	ATMK 36	N14.1 WXGAG	SO1G BII6	N	N120 GB5.4 K	NSM8 X	ABT_ATH54 13BG	N	N
AS5051AWX Mi	AAP	Malaysia	LX.AV 30J.016	AS5051AW XMi MCEMA1 UMAC 1*1G/120/ 6L/5R/ CB_bg_0.3 C_AN	ATMK 36	N14.1 WXGAG	SO1G BII6	N	N120 GB5.4 K	NSM8 X	ABT_ATH54 13BG	N	N

Model	RO	Country	Acer Part no	Description	CPU	LCD	DIMM 1	DIMM 2	HDD 1 (GB)	ODD	Wireless LAN	Bluetooth	VOIP Phone
AS5051AWXMi	AAP	Thailand	LX.AV30J.017	AS5051AWXMi MCETH1 UMAC 1*1G/120/ 6L/5R/ CB_bg_0.3 C_AN	ATMK36	N14.1WXGAG	SO1GBII6	N	N120GB5.4K	NSM8X	ABT_ATH5413BG	N	N
AS5051AWXMi	AAP	Vietnam	LX.AV30J.018	AS5051AWXMi MCEVN1 UMAC 1*1G/120/ 6L/5R/ CB_bg_0.3 C_AN	ATMK36	N14.1WXGAG	SO1GBII6	N	N120GB5.4K	NSM8X	ABT_ATH5413BG	N	N
AS5051AWXMi	AAP	Australia/ New Zealand	LX.AV306.002	AS5051AWXMi XPPAU1 UMAC 1*1G/120/ 6L/5R/ CB_bg_0.3 C_AN	ATMK36	N14.1WXGAG	SO1GBII6	N	N120GB5.4K	NSM8X	ABT_ATH5413BG	N	N
AS5052WXM i	AAP	Australia/ New Zealand	LX.AV30J.003	AS5052WXM i MCEAU1 UMAC 1*1G/120/ 6L/5R/ CB_bg_0.3 C_AN	ATTL50	N14.1WXGAG	SO1GBII6	N	N120GB5.4K	NSM8X	ABT_ATH5413BG	N	N
AS5052WXM i	AAP	India	LX.AV30J.005	AS5052WXM i MCEIL1 UMAC 1*1G/120/ 6L/5R/ CB_bg_0.3 C_AN	ATTL50	N14.1WXGAG	SO1GBII6	N	N120GB5.4K	NSM8X	ABT_ATH5413BG	N	N
AS5052WXM i	AAP	Indonesia	LX.AV30J.006	AS5052WXM i MCEIN1 UMAC 1*1G/120/ 6L/5R/ CB_bg_0.3 C_AN	ATTL50	N14.1WXGAG	SO1GBII6	N	N120GB5.4K	NSM8X	ABT_ATH5413BG	N	N
AS5052WXM i	AAP	Singapore	LX.AV30J.004	AS5052WXM i MCESG1 UMAC 1*1G/120/ 6L/5R/ CB_bg_0.3 C_AN	ATTL50	N14.1WXGAG	SO1GBII6	N	N120GB5.4K	NSM8X	ABT_ATH5413BG	N	N
AS5052WXM i	AAP	Philippines	LX.AV30J.007	AS5052WXM i MCEPH1 UMAC 1*1G/120/ 6L/5R/ CB_bg_0.3 C_AN	ATTL50	N14.1WXGAG	SO1GBII6	N	N120GB5.4K	NSM8X	ABT_ATH5413BG	N	N
AS5052WXM i	AAP	Malaysia	LX.AV30J.008	AS5052WXM i MCEMA1 UMAC 1*1G/120/ 6L/5R/ CB_bg_0.3 C_AN	ATTL50	N14.1WXGAG	SO1GBII6	N	N120GB5.4K	NSM8X	ABT_ATH5413BG	N	N

Model	RO	Country	Acer Part no	Description	CPU	LCD	DIMM 1	DIMM 2	HDD 1 (GB)	ODD	Wireless LAN	Bluetooth	VOIP Phone
AS5052WXM i	AAP	Thailand	LX.AV 30J.009	AS5052WXM i MCETH1 UMAC 1*1G/120/ 6L/5R/ CB_bg_0.3 C_AN	ATTL50	N14.1 WXGAG	SO1G BII6	N	N120 GB5.4 K	NSM8 X	ABT_ATH54 13BG	N	N
AS5052WXM i	AAP	Vietnam	LX.AV 30J.010	AS5052WXM i MCEVN1 UMAC 1*1G/120/ 6L/5R/ CB_bg_0.3 C_AN	ATTL50	N14.1 WXGAG	SO1G BII6	N	N120 GB5.4 K	NSM8 X	ABT_ATH54 13BG	N	N
AS5052WXM i	AAP	Australia/ New Zealand	LX.AV 306.001	AS5052WXM i MiXPPAU1 UMAC 1*1G/120/ 6L/5R/ CB_bg_0.3 C_AN	ATTL50	N14.1 WXGAG	SO1G BII6	N	N120 GB5.4 K	NSM8 X	ABT_ATH54 13BG	N	N
AS5051ANW XM i	AAP	India	LX.AV 30C.015	AS5051ANW XM i LINPUSIL1 UMAC 1*256/60/ 6L/5R/ CB_bg_0.3 C_AN	ATMK36	N14.1 WXGAG	SO256 MBII5	N	N60G B5.4K	NSM8 X	ABT_ATH54 13BG	N	N
AS5051ANW XM i	AAP	Vietnam	LX.AV 30C.014	AS5051ANW XM i LINPUSVN1 UMAC 1*512/60/ 6L/5R/ CB_bg_0.3 C_AN	ATMK36	N14.1 WXGAG	SO512 MBII5	N	N60G B5.4K	NSM8 X	ABT_ATH54 13BG	N	N
AS5051ANW XM i	AAP	Thailand	LX.AV 30C.016	AS5051ANW XM i LINPUSH2 UMAC 1*512/80/ BT/6L/5R/ CB_bg_0.3 C_AN	ATMK36	N14.1 WXGAG	SO512 MBII5	N	N80G B5.4K	NSM8 X	ABT_ATH54 13BG	FOX_BRM_2.0	N
AS5051ANW XM i	AAP	Singapore	LX.AV 30C.008	AS5051ANW XM i LINPUSSG1 UMAC 1*512/60/ 6L/5R/ CB_bg_0.3 C_AN	ATMK36	N14.1 WXGAG	SO512 MBII5	N	N60G B5.4K	NSM8 X	ABT_ATH54 13BG	N	N
AS5051ANW XM i	AAP	India	LX.AV 30C.009	AS5051ANW XM i LINPUSIL1 UMAC 1*512/60/ 6L/5R/ CB_bg_0.3 C_AN	ATMK36	N14.1 WXGAG	SO512 MBII5	N	N60G B5.4K	NSM8 X	ABT_ATH54 13BG	N	N
AS5051ANW XM i	AAP	Indonesia	LX.AV 30C.010	AS5051ANW XM i LINPUSIN1 UMAC 1*512/60/ 6L/5R/ CB_bg_0.3 C_AN	ATMK36	N14.1 WXGAG	SO512 MBII5	N	N60G B5.4K	NSM8 X	ABT_ATH54 13BG	N	N

Model	RO	Country	Acer Part no	Description	CPU	LCD	DIMM 1	DIMM 2	HDD 1 (GB)	ODD	Wireless LAN	Bluetooth	VOIP Phone
AS5051ANW XMi	AAP	Philippines	LX.AV30C.011	AS5051AN WXMi LINPUSPH1 UMAC 1*512/60/6L/5R/ CB_bg_0.3 C_AN	ATMK36	N14.1 WXGAG	SO512 MBII5	N	N60GB5.4K	NSM8X	ABT_ATH5413BG	N	N
AS5051ANW XMi	AAP	Malaysia	LX.AV30C.012	AS5051AN WXMi LINPUSMA2 UMAC 1*512/60/6L/5R/ CB_bg_0.3 C_AN	ATMK36	N14.1 WXGAG	SO512 MBII5	N	N60GB5.4K	NSM8X	ABT_ATH5413BG	N	N
AS5051ANW XMi	AAP	Thailand	LX.AV30C.013	AS5051AN WXMi LINPUSHT2 UMAC 1*512/60/6L/5R/ CB_bg_0.3 C_AN	ATMK36	N14.1 WXGAG	SO512 MBII5	N	N60GB5.4K	NSM8X	ABT_ATH5413BG	N	N
AS5052WXM i	AAP	Thailand	LX.AV30J.019	AS5052WXM i MCETH1 UMAC 1*1G/120/BT/6L/5R/ CB_bg_0.3 C_AN	ATTL50	N14.1 WXGAG	SO1GBII6	N	N120GB5.4K	NSM8X	ABT_ATH5413BG	FOX_BRM_2.0	N
AS5051AWX Mi	EMEA	Belgium	LX.AV30J.032	AS5051AW XMi MCEBE6 UMAC 2*512/100/6L/5R_bg_0.3 C_AN	ATMK36	N14.1 WXGAG	SO512 MBII6	SO512 MBII6	N100GB5.4K	NSM8X	ABT_BRM4318BG	N	N
AS5051AWX Mi	EMEA	Middle East	LX.AV30J.043	AS5051AW XMi MCEAR1 UMAC 2*512/100/6L/5R_bg_0.3 C_AN	ATMK36	N14.1 WXGAG	SO512 MBII6	SO512 MBII6	N100GB5.4K	NSM8X	ABT_BRM4318BG	N	N
AS5051AWX Mi	EMEA	Middle East	LX.AV30J.044	AS5051AW XMi MCEAR2 UMAC 2*512/100/6L/5R_bg_0.3 C_AN	ATMK36	N14.1 WXGAG	SO512 MBII6	SO512 MBII6	N100GB5.4K	NSM8X	ABT_BRM4318BG	N	N
AS5051AWX Mi	EMEA	Italy	LX.AV30J.040	AS5051AW XMi MCEIT7 UMAC 2*512/100/6L/5R_bg_0.3 C_AN	ATMK36	N14.1 WXGAG	SO512 MBII6	SO512 MBII6	N100GB5.4K	NSM8X	ABT_BRM4318BG	N	N
AS5051AWX Mi	EMEA	Spain	LX.AV30J.039	AS5051AW XMi MCEESJ UMAC 2*512/100/6L/5R_bg_0.3 C_AN	ATMK36	N14.1 WXGAG	SO512 MBII6	SO512 MBII6	N100GB5.4K	NSM8X	ABT_BRM4318BG	N	N

Model	RO	Country	Acer Part no	Description	CPU	LCD	DIMM 1	DIMM 2	HDD 1 (GB)	ODD	Wireless LAN	Bluetooth	VOIP Phone
AS5051AWX Mi	EMEA	Eastern Europe	LX.AV 30J.030	AS5051AW XMi MCECS5 UMAC 2*512/100/6L/ 5R_bg_0.3 C_AN	ATMK 36	N14.1 WXGA	SO512 MBII6	SO512 MBII6	N100 GB5.4 K	NSM8 X	ABT_BRM4 318BG	N	N
AS5051AWX Mi	EMEA	Denmark	LX.AV 30J.024	AS5051AW XMi MCEDK6 UMAC 2*512/100/6L/ 5R_bg_0.3 C_AN	ATMK 36	N14.1 WXGA	SO512 MBII6	SO512 MBII6	N100 GB5.4 K	NSM8 X	ABT_BRM4 318BG	N	N
AS5051AWX Mi	EMEA	France	LX.AV 30J.025	AS5051AW XMi MCEFRF UMAC 2*512/100/6L/ 5R_bg_0.3 C_AN	ATMK 36	N14.1 WXGA	SO512 MBII6	SO512 MBII6	N100 GB5.4 K	NSM8 X	ABT_BRM4 318BG	N	N
AS5051AWX Mi	EMEA	Germany	LX.AV 30J.027	AS5051AW XMi MCEDEA UMAC 2*512/100/6L/ 5R_bg_0.3 C_AN	ATMK 36	N14.1 WXGA	SO512 MBII6	SO512 MBII6	N100 GB5.4 K	NSM8 X	ABT_BRM4 318BG	N	N
AS5051AWX Mi	EMEA	Germany	LX.AV 30J.028	AS5051AW XMi MCEDEB UMAC 2*512/100/6L/ 5R_bg_0.3 C_AN	ATMK 36	N14.1 WXGA	SO512 MBII6	SO512 MBII6	N100 GB5.4 K	NSM8 X	ABT_BRM4 318BG	N	N
AS5051AWX Mi	EMEA	Holland	LX.AV 30J.033	AS5051AW XMi MCENL6 UMAC 2*512/100/6L/ 5R_bg_0.3 C_AN	ATMK 36	N14.1 WXGA	SO512 MBII6	SO512 MBII6	N100 GB5.4 K	NSM8 X	ABT_BRM4 318BG	N	N
AS5051AWX Mi	EMEA	Norway	LX.AV 30J.034	AS5051AW XMi MCENO5 UMAC 2*512/100/6L/ 5R_bg_0.3 C_AN	ATMK 36	N14.1 WXGA	SO512 MBII6	SO512 MBII6	N100 GB5.4 K	NSM8 X	ABT_BRM4 318BG	N	N
AS5051AWX Mi	EMEA	Russia	LX.AV 30J.035	AS5051AW XMi MCERU9 UMAC 2*512/100/6L/ 5R_bg_0.3 C_AN	ATMK 36	N14.1 WXGA	SO512 MBII6	SO512 MBII6	N100 GB5.4 K	NSM8 X	ABT_BRM4 318BG	N	N
AS5051AWX Mi	EMEA	Eastern Europe	LX.AV 30J.036	AS5051AW XMi MCEPL7 UMAC 2*512/100/6L/ 5R_bg_0.3 C_AN	ATMK 36	N14.1 WXGA	SO512 MBII6	SO512 MBII6	N100 GB5.4 K	NSM8 X	ABT_BRM4 318BG	N	N

Model	RO	Country	Acer Part no	Description	CPU	LCD	DIMM 1	DIMM 2	HDD 1 (GB)	ODD	Wireless LAN	Bluetooth	VOIP Phone
AS5051AWX Mi	EMEA	Slovenia/Croatia	LX.AV 30J.037	AS5051AW XMi MCES11 UMAC 2*512/100/6L/ 5R_bg_0.3 C_AN	ATMK 36	N14.1 WXGA	SO512 MBII6	SO512 MBII6	N100 GB5.4 K	NSM8 X	ABT_BRM4 318BG	N	N
AS5051AWX Mi	EMEA	Portugal	LX.AV 30J.038	AS5051AW XMi MCEPT6 UMAC 2*512/100/6L/ 5R_bg_0.3 C_AN	ATMK 36	N14.1 WXGA	SO512 MBII6	SO512 MBII6	N100 GB5.4 K	NSM8 X	ABT_BRM4 318BG	N	N
AS5051AWX Mi	EMEA	Sweden/Finland	LX.AV 30J.029	AS5051AW XMi MCESV5 UMAC 2*512/100/6L/ 5R_bg_0.3 C_AN	ATMK 36	N14.1 WXGA	SO512 MBII6	SO512 MBII6	N100 GB5.4 K	NSM8 X	ABT_BRM4 318BG	N	N
AS5051AWX Mi	EMEA	Turkey	LX.AV 30J.041	AS5051AW XMi MCETR5 UMAC 2*512/100/6L/ 5R_bg_0.3 C_AN	ATMK 36	N14.1 WXGA	SO512 MBII6	SO512 MBII6	N100 GB5.4 K	NSM8 X	ABT_BRM4 318BG	N	N
AS5051AWX Mi	EMEA	Switzerland	LX.AV 30J.045	AS5051AW XMi MCESW8 UMAC 2*512/100/6L/ 5R_bg_0.3 C_AN	ATMK 36	N14.1 WXGA	SO512 MBII6	SO512 MBII6	N100 GB5.4 K	NSM8 X	ABT_BRM4 318BG	N	N
AS5051AWX Mi	EMEA	UK	LX.AV 30J.046	AS5051AW XMi MCEUK5 UMAC 2*512/100/6L/ 5R_bg_0.3 C_AN	ATMK 36	N14.1 WXGA	SO512 MBII6	SO512 MBII6	N100 GB5.4 K	NSM8 X	ABT_BRM4 318BG	N	N
AS5051AWX Mi	EMEA	UK	LX.AV 30J.047	AS5051AW XMi MCEWUK1 1W UMAC 2*512/100/6L/ 5R_bg_0.3 C_AN	ATMK 36	N14.1 WXGA	SO512 MBII6	SO512 MBII6	N100 GB5.4 K	NSM8 X	ABT_BRM4 318BG	N	N
AS5051AWX Mi	EMEA	Italy	LX.AV 30J.042	AS5051AW XMi MCEWIT11 W UMAC 2*512/100/6L/ 5R_bg_0.3 C_AN	ATMK 36	N14.1 WXGA	SO512 MBII6	SO512 MBII6	N100 GB5.4 K	NSM8 X	ABT_BRM4 318BG	N	N
AS5051AWX Mi	EMEA	Germany	LX.AV 30J.031	AS5051AW XMi MCEWDE1 1W UMAC 2*512/100/6L/ 5R_bg_0.3 C_AN	ATMK 36	N14.1 WXGA	SO512 MBII6	SO512 MBII6	N100 GB5.4 K	NSM8 X	ABT_BRM4 318BG	N	N



Model	RO	Country	Acer Part no	Description	CPU	LCD	DIMM 1	DIMM 2	HDD 1 (GB)	ODD	Wireless LAN	Bluetooth	VOIP Phone
AS5051AWX Mi	EMEA	France	LX.AV 30J.026	AS5051AW XMi MCEWFR1 1W UMAC 2*512/100/6L/ 5R_bg_0.3 C_AN	ATMK 36	N14.1 WXGA	SO512 MBII6	SO512 MBII6	N100 GB5.4 K	NSM8 X	ABT_BRM4 318BG	N	N
AS5051AWX Mi	EMEA	Belgium	LX.AV 305.019	AS5051AW XMi XPHBE1 UMAC 2*512/100/6L/ 5R_bg_0.3 C_AN	ATMK 36	N14.1 WXGA	SO512 MBII6	SO512 MBII6	N100 GB5.4 K	NSM8 X	ABT_BRM4 318BG	N	N
AS5051AWX Mi	EMEA	Middle East	LX.AV 305.038	AS5051AW XMi XPHAR1 UMAC 2*512/100/6L/ 5R_bg_0.3 C_AN	ATMK 36	N14.1 WXGA	SO512 MBII6	SO512 MBII6	N100 GB5.4 K	NSM8 X	ABT_BRM4 318BG	N	N
AS5051AWX Mi	EMEA	Eastern Europe	LX.AV 305.027	AS5051AW XMi XPHCS2 UMAC 2*512/100/6L/ 5R_bg_0.3 C_AN	ATMK 36	N14.1 WXGA	SO512 MBII6	SO512 MBII6	N100 GB5.4 K	NSM8 X	ABT_BRM4 318BG	N	N
AS5051AWX Mi	EMEA	Germany	LX.AV 305.023	AS5051AW XMi XPHDE7 UMAC 2*512/100/6L/ 5R_bg_0.3 C_AN	ATMK 36	N14.1 WXGA	SO512 MBII6	SO512 MBII6	N100 GB5.4 K	NSM8 X	ABT_BRM4 318BG	N	N
AS5051AWX Mi	EMEA	Greece	LX.AV 305.033	AS5051AW XMi XPHL1 UMAC 2*512/100/6L/ 5R_bg_0.3 C_AN	ATMK 36	N14.1 WXGA	SO512 MBII6	SO512 MBII6	N100 GB5.4 K	NSM8 X	ABT_BRM4 318BG	N	N
AS5051AWX Mi	EMEA	Israel	LX.AV 305.034	AS5051AW XMi XPHIS1 UMAC 2*512/100/6L/ 5R_bg_0.3 C_AN	ATMK 36	N14.1 WXGA	SO512 MBII6	SO512 MBII6	N100 GB5.4 K	NSM8 X	ABT_BRM4 318BG	N	N
AS5051AWX Mi	EMEA	Italy	LX.AV 305.035	AS5051AW XMi XPHIT1 UMAC 2*512/100/6L/ 5R_bg_0.3 C_AN	ATMK 36	N14.1 WXGA	SO512 MBII6	SO512 MBII6	N100 GB5.4 K	NSM8 X	ABT_BRM4 318BG	N	N
AS5051AWX Mi	EMEA	Denmark	LX.AV 305.018	AS5051AW XMi XPHDK1 UMAC 2*512/100/6L/ 5R_bg_0.3 C_AN	ATMK 36	N14.1 WXGA	SO512 MBII6	SO512 MBII6	N100 GB5.4 K	NSM8 X	ABT_BRM4 318BG	N	N

Model	RO	Country	Acer Part no	Description	CPU	LCD	DIMM 1	DIMM 2	HDD 1 (GB)	ODD	Wireless LAN	Bluetooth	VOIP Phone
AS5051AWX Mi	EMEA	Holland	LX.AV305.020	AS5051AWXMi XPHNL1 UMAC 2*512/100/6L/ 5R_bg_0.3 C_AN	ATMK36	N14.1 WXGA	SO512 MBII6	SO512 MBII6	N100 GB5.4 K	NSM8 X	ABT_BRM4 318BG	N	N
AS5051AWX Mi	EMEA	France	LX.AV305.021	AS5051AWXMi XPHFRA UMAC 2*512/100/6L/ 5R_bg_0.3 C_AN	ATMK36	N14.1 WXGA	SO512 MBII6	SO512 MBII6	N100 GB5.4 K	NSM8 X	ABT_BRM4 318BG	N	N
AS5051AWX Mi	EMEA	Eastern Europe	LX.AV305.028	AS5051AWXMi XPHHU6 UMAC 2*512/100/6L/ 5R_bg_0.3 C_AN	ATMK36	N14.1 WXGA	SO512 MBII6	SO512 MBII6	N100 GB5.4 K	NSM8 X	ABT_BRM4 318BG	N	N
AS5051AWX Mi	EMEA	Spain	LX.AV305.031	AS5051AWXMi XPHESA UMAC 2*512/100/6L/ 5R_bg_0.3 C_AN	ATMK36	N14.1 WXGA	SO512 MBII6	SO512 MBII6	N100 GB5.4 K	NSM8 X	ABT_BRM4 318BG	N	N
AS5051AWX Mi	EMEA	Slovenia/Croatia	LX.AV305.030	AS5051AWXMi XPHSLO2 UMAC 2*512/100/6L/ 5R_bg_0.3 C_AN	ATMK36	N14.1 WXGA	SO512 MBII6	SO512 MBII6	N100 GB5.4 K	NSM8 X	ABT_BRM4 318BG	N	N
AS5051AWX Mi	EMEA	Eastern Europe	LX.AV305.029	AS5051AWXMi XPHPL6 UMAC 2*512/100/6L/ 5R_bg_0.3 C_AN	ATMK36	N14.1 WXGA	SO512 MBII6	SO512 MBII6	N100 GB5.4 K	NSM8 X	ABT_BRM4 318BG	N	N
AS5051AWX Mi	EMEA	Portugal	LX.AV305.032	AS5051AWXMi XPHPT1 UMAC 2*512/100/6L/ 5R_bg_0.3 C_AN	ATMK36	N14.1 WXGA	SO512 MBII6	SO512 MBII6	N100 GB5.4 K	NSM8 X	ABT_BRM4 318BG	N	N
AS5051AWX Mi	EMEA	Switzerland	LX.AV305.039	AS5051AWXMi XPHSW5 UMAC 2*512/100/6L/ 5R_bg_0.3 C_AN	ATMK36	N14.1 WXGA	SO512 MBII6	SO512 MBII6	N100 GB5.4 K	NSM8 X	ABT_BRM4 318BG	N	N
AS5051AWX Mi	EMEA	Turkey	LX.AV305.036	AS5051AWXMi XPHTR1 UMAC 2*512/100/6L/ 5R_bg_0.3 C_AN	ATMK36	N14.1 WXGA	SO512 MBII6	SO512 MBII6	N100 GB5.4 K	NSM8 X	ABT_BRM4 318BG	N	N

Model	RO	Country	Acer Part no	Description	CPU	LCD	DIMM 1	DIMM 2	HDD 1 (GB)	ODD	Wireless LAN	Bluetooth	VOIP Phone
AS5051AWX Mi	EMEA	South Africa	LX.AV 305.017	AS5051AW XMi XPHSA1 UMAC 2*512/100/6L/ 5R_bg_0.3 C_AN	ATMK 36	N14.1 WXGA	SO512 MBII6	SO512 MBII6	N100 GB5.4 K	NSM8 X	ABT_BRM4 318BG	N	N
AS5051AWX Mi	EMEA	Norway	LX.AV 305.024	AS5051AW XMi XPHNO1 UMAC 2*512/100/6L/ 5R_bg_0.3 C_AN	ATMK 36	N14.1 WXGA	SO512 MBII6	SO512 MBII6	N100 GB5.4 K	NSM8 X	ABT_BRM4 318BG	N	N
AS5051AWX Mi	EMEA	Russia	LX.AV 305.025	AS5051AW XMi XPHRU2 UMAC 2*512/100/6L/ 5R_bg_0.3 C_AN	ATMK 36	N14.1 WXGA	SO512 MBII6	SO512 MBII6	N100 GB5.4 K	NSM8 X	ABT_BRM4 318BG	N	N
AS5051AWX Mi	EMEA	Sweden/ Finland	LX.AV 305.026	AS5051AW XMi XPHSV1 UMAC 2*512/100/6L/ 5R_bg_0.3 C_AN	ATMK 36	N14.1 WXGA	SO512 MBII6	SO512 MBII6	N100 GB5.4 K	NSM8 X	ABT_BRM4 318BG	N	N
AS5051AWX Mi	EMEA	France	LX.AV 305.022	AS5051AW XMi XPHWFRB 1W UMAC 2*512/100/6L/ 5R_bg_0.3 C_AN	ATMK 36	N14.1 WXGA	SO512 MBII6	SO512 MBII6	N100 GB5.4 K	NSM8 X	ABT_BRM4 318BG	N	N
AS5051AWX Mi	EMEA	Italy	LX.AV 305.037	AS5051AW XMi XPHWIT21 W UMAC 2*512/100/6L/ 5R_bg_0.3 C_AN	ATMK 36	N14.1 WXGA	SO512 MBII6	SO512 MBII6	N100 GB5.4 K	NSM8 X	ABT_BRM4 318BG	N	N
AS5051AWX Mi	EMEA	UK	LX.AV 305.040	AS5051AW XMi XPHUK1 UMAC 2*512/100/6L/ 5R_bg_0.3 C_AN	ATMK 36	N14.1 WXGA	SO512 MBII6	SO512 MBII6	N100 GB5.4 K	NSM8 X	ABT_BRM4 318BG	N	N
AS5051AWX Mi	EMEA	UK	LX.AV 305.041	AS5051AW XMi XPHWUK2 1W UMAC 2*512/100/6L/ 5R_bg_0.3 C_AN	ATMK 36	N14.1 WXGA	SO512 MBII6	SO512 MBII6	N100 GB5.4 K	NSM8 X	ABT_BRM4 318BG	N	N
AS5052WXM i	PA	USA/ Canada - Canadian French	LX.AV 30J.020	AS5052WXM i MCECF UMAC 2*512/120/6L/5R/ CB_bg_0.3 C_AN	ATTL5 0	N14.1 WXGA G	SO512 MBII5	SO512 MBII5	N120 GB5.4 K	NSM8 X	ABT_ATH54 13BG	N	N

Model	RO	Country	Acer Part no	Description	CPU	LCD	DIMM 1	DIMM 2	HDD 1 (GB)	ODD	Wireless LAN	Bluetooth	VOIP Phone
AS5052WXM i	PA	USA/ Canada - Canadian French	LX.AV 30J.02 1	AS5052WX Mi MCEUS UMAC 2*512/120/ 6L/5R/ CB_bg_0.3 C_AN	ATTL5 0	N14.1 WXGA G	SO512 MBII5	SO512 MBII5	N120 GB5.4 K	NSM8 X	ABT_ATH54 13BG	N	N
AS5052WXM i	PA	ACLA-Spanish	LX.AV 30J.02 2	AS5052WX Mi MCEES1 UMAC 2*512/120/ 6L/5R/ CB_bg_0.3 C_AN	ATTL5 0	N14.1 WXGA G	SO512 MBII5	SO512 MBII5	N120 GB5.4 K	NSM8 X	ABT_ATH54 13BG	N	N
AS5051AWX Mi	PA	ACLA-Spanish	LX.AV 30J.04 8	AS5051AW XMi MCEES1 UMAC 2*512/120/ 6L/5R/ CB_bg_0.3 C_AN	ATMK 36	N14.1 WXGA G	SO512 MBII5	SO512 MBII5	N120 GB5.4 K	NSM8 X	ABT_BRM4 318BG	N	N
AS5051ANW XCi	AAP	Australia/ New Zealand	LX.AV 30C.0 17	AS5051AN WXCi LINPUSAU 1 UMAC 1*512/80/ 6L/5R/ CB_bg_0.3 C_AN	ATMK 36	N14.1 WXGA G	SO512 MBII5	N	N80G B5.4K	NCB2 4X	ABT_BRM4 318BG	N	N
AS5051AWX Ci	AAP	Malaysia	LX.AV 305.04 2	AS5051AW XCi XPHMA2 UMAC 1*512/80/ 6L/5R/ CB_bg_0.3 C_AN	ATMK 36	N14.1 WXGA G	SO512 MBII5	N	N80G B5.4K	NCB2 4X	ABT_BRM4 318BG	N	N
AS5051ANW XCi	AAP	Malaysia	LX.AV 30C.0 18	AS5051AN WXCi LINPUSMA 2 UMAC 1*512/80/ 6L/5R/ CB_bg_0.3 C_AN	ATMK 36	N14.1 WXGA G	SO512 MBII5	N	N80G B5.4K	NCB2 4X	ABT_BRM4 318BG	N	N
AS5051AWX Mi	EMEA	Sweden/ Finland	LX.AV 30J.04 9	AS5051AW XMi MCEV5 UMAC 1*512/100/ BT/6L/5R/ CB_bg_VP_0.3C_AN	ATMK 36	N14.1 WXGA G	SO512 MBII6	N	N100 GB5.4 K	NSM8 X	ABT_BRM4 318BG	FOX_BRM_ 2.0	BT VoIP PCMC IA
AS5051AWX Mi	EMEA	Slovenia/ Croatia	LX.AV 30J.05 0	AS5051AW XMi MCEES1 UMAC 1*512/100/ BT/6L/5R/ CB_bg_VP_0.3C_AN	ATMK 36	N14.1 WXGA G	SO512 MBII6	N	N100 GB5.4 K	NSM8 X	ABT_BRM4 318BG	FOX_BRM_ 2.0	BT VoIP PCMC IA
AS5051AWX Mi	EMEA	Holland	LX.AV 30J.05 1	AS5051AW XMi MCENL6 UMAC 1*512/100/ BT/6L/5R/ CB_bg_VP_0.3C_AN	ATMK 36	N14.1 WXGA G	SO512 MBII6	N	N100 GB5.4 K	NSM8 X	ABT_BRM4 318BG	FOX_BRM_ 2.0	BT VoIP PCMC IA

Model	RO	Country	Acer Part no	Description	CPU	LCD	DIMM 1	DIMM 2	HDD 1 (GB)	ODD	Wireless LAN	Bluetooth	VOIP Phone
AS5051AWX Mi	EMEA	Russia	LX.AV 30J.05 2	AS5051AW XMi MCERU9 UMAC 1*512/100/ BT/6L/5R/ CB_bg_VP_0.3C_AN	ATMK 36	N14.1 WXGA G	SO512 MBII6	N	N100 GB5.4 K	NSM8 X	ABT_BRM4 318BG	FOX_BRM_2.0	BT VoIP PCMC IA
AS5051AWX Mi	EMEA	Holland	LX.AV 30J.05 4	AS5051AW XMi MCENL6 UMAC 1*512/100/ BT/6L/ 5R_bg_VP_0.3C_AN	ATMK 36	N14.1 WXGA	SO512 MBII6	N	N100 GB5.4 K	NSM8 X	ABT_BRM4 318BG	FOX_BRM_2.0	BT VoIP PCMC IA
AS5051AWX Mi	EMEA	Russia	LX.AV 305.04 3	AS5051AW XMi XPHRU2 UMAC 1*512/100/ 6L/ 5R_bg_0.3 C_AN	ATMK 36	N14.1 WXGA	SO512 MBII6	N	N100 GB5.4 K	NSM8 X	ABT_BRM4 318BG	N	N
AS5051AWX Mi	EMEA	Sweden/ Finland	LX.AV 30J.05 5	AS5051AW XMi MCESV5 UMAC 1*512/100/ BT/6L/ 5R_bg_VP_0.3C_AN	ATMK 36	N14.1 WXGA	SO512 MBII6	N	N100 GB5.4 K	NSM8 X	ABT_BRM4 318BG	FOX_BRM_2.0	BT VoIP PCMC IA
AS5051AWX Mi	EMEA	Slovenia/ Croatia	LX.AV 30J.05 3	AS5051AW XMi MCESI1 UMAC 1*512/100/ BT/6L/ 5R_bg_VP_0.3C_AN	ATMK 36	N14.1 WXGA	SO512 MBII6	N	N100 GB5.4 K	NSM8 X	ABT_BRM4 318BG	FOX_BRM_2.0	BT VoIP PCMC IA
AS5052NWX Mi	AAP	Thailand	LX.AV 30C.0 19	AS5052N WXMi LINPUSH 2 UMAC 1*512/120/ BT/6L/5R/ CB_bg_0.3 C_AN	ATTL5 0	N14.1 WXGA G	SO512 MBII5	N	N120 GB5.4 K	NSM8 X	ABT_BRM4 318BG	FOX_BRM_2.0	N
AS5053WXM i	AAP	Thailand	LX.AV 30J.05 6	AS5053WX Mi MCETH1 UMAC 1*1G/120/ BT/6L/5R/ CB_bg_0.3 C_AN	ATTL5 2	N14.1 WXGA G	SO1G BII6	N	N120 GB5.4 K	NSM8 X	ABT_BRM4 318BG	FOX_BRM_2.0	N
AS5051ANW XMi	EMEA	Middle East	LX.AV 30C.0 22	AS5051AN WXMi LINPUSAR 9 UMAC 1*512/60/ BT/6L/ 5R_bg_0.3 C_AN	ATMK 36	N14.1 WXGA	SO512 MBII5	N	N60G B5.4K	NSM8 X	ABT_BRM4 318BG	FOX_BRM_2.0	N
AS5051ANW XMi	EMEA	Middle East	LX.AV 30C.0 24	AS5051AN WXMi LINPUSAR 9 UMAC 1*512/60/ BT/6L/5R/ CB_bg_0.3 C_AN	ATMK 36	N14.1 WXGA G	SO512 MBII5	N	N60G B5.4K	NSM8 X	ABT_BRM4 318BG	FOX_BRM_2.0	N

Model	RO	Country	Acer Part no	Description	CPU	LCD	DIMM 1	DIMM 2	HDD 1 (GB)	ODD	Wireless LAN	Bluetooth	VOIP Phone
AS5051ANW XMi	EMEA	Middle East	LX.AV 30C.0 20	AS5051AN WXMi LINPUSAR 7 UMAC 1*512/60/ BT/6L/ 5R_bg_0.3 C_AN	ATMK 36	N14.1 WXGA	SO512 MBII5	N	N60G B5.4K	NSM8 X	ABT_BRM4 318BG	FOX_BRM_ 2.0	N
AS5051ANW XMi	EMEA	France	LX.AV 30C.0 21	AS5051AN WXMi LINPUSFR A UMAC 1*512/60/ 6L/ 5R_bg_0.3 C_AN	ATMK 36	N14.1 WXGA	SO512 MBII5	N	N60G B5.4K	NSM8 X	ABT_BRM4 318BG	N	N
AS5051ANW XMi	EMEA	Russia	LX.AV 30C.0 23	AS5051AN WXMi LINPUSRU 5 UMAC 1*512/60/ 6L/ 5R_bg_0.3 C_AN	ATMK 36	N14.1 WXGA	SO512 MBII5	N	N60G B5.4K	NSM8 X	ABT_BRM4 318BG	N	N
AS5051AWX Mi	EMEA	Middle East	LX.AV 305.04 4	AS5051AW XMi XPHAR8 UMAC 1*512/60/ BT/6L/5R/ CB_bg_0.3 C_AN	ATMK 36	N14.1 WXGA G	SO512 MBII5	N	N60G B5.4K	NSM8 X	ABT_BRM4 318BG	FOX_BRM_ 2.0	N
AS5051AWX Mi	EMEA	Eastern Europe	LX.AV 30J.05 7	AS5051AW XMi MCEPL7 UMAC 1*512/100/ BT/6L/ 5R_bg_VP _0.3C_AN	ATMK 36	N14.1 WXGA	SO512 MBII6	N	N100 GB5.4 K	NSM8 X	ABT_BRM4 318BG	FOX_BRM_ 2.0	BT VoIP PCMC IA
AS5051AWX Mi	EMEA	Russia	LX.AV 305.04 5	AS5051AW XMi XPHRU1 UMAC 1*512/100/ BT/6L/ 5R_bg_VP _0.3C_AN	ATMK 36	N14.1 WXGA	SO512 MBII6	N	N100 GB5.4 K	NSM8 X	ABT_BRM4 318BG	FOX_BRM_ 2.0	BT VoIP PCMC IA
AS5052WXM i	TWN	GCTWN	LX.AV 30J.05 8	AS5052WXM i MCETC9 UMAC 1*512/120/ BT/6L/5R/ CB_bg_0.3 C_AN	ATTL5 0	N14.1 WXGA G	SO512 MBII5	N	N120 GB5.4 K	NSM8 X	ABT_BRM4 318BG	FOX_BRM_ 2.0	N
AS5052WXM i	TWN	GCTWN	LX.AV 305.04 6	AS5052WXM i XPHTC1 UMAC 1*512/120/ BT/6L/5R/ CB_bg_0.3 C_AN	ATTL5 0	N14.1 WXGA G	SO512 MBII5	N	N120 GB5.4 K	NSM8 X	ABT_ATH54 13BG	FOX_BRM_ 2.0	N
AS5051AWX Mi	EMEA	Switzerland	LX.AV 30J.05 9	AS5051AW XMi MCESW8 UMAC 2*512/120/ BT/6L/5R/ CB_bg_0.3 C_AN	ATMK 36	N14.1 WXGA G	SO512 MBII5	SO512 MBII5	N120 GB5.4 K	NSM8 X	ABT_BRM4 318BG	FOX_BRM_ 2.0	N

Model	RO	Country	Acer Part no	Description	CPU	LCD	DIMM 1	DIMM 2	HDD 1 (GB)	ODD	Wireless LAN	Bluetooth	VOIP Phone
AS5051AWX Mi	EMEA	Switzerland	LX.AV 30J.06 0	AS5051AW XMi MCESW8 UMAC 2*512/120/ 6L/5R/ CB_bg_0.3 C_AN	ATMK 36	N14.1 WXGA G	SO512 MBII5	SO512 MBII5	N120 GB5.4 K	NSM8 X	ABT_BRM4 318BG	N	N
AS5051AWX Mi	EMEA	Portugal	LX.AV 30J.06 1	AS5051AW XMi MCEPT6 UMAC 2*512/120/ 6L/ 5R_bg_0.3 C_AN	ATMK 36	N14.1 WXGA	SO512 MBII5	SO512 MBII5	N120 GB5.4 K	NSM8 X	ABT_BRM4 318BG	N	N
AS5051AWX Mi	EMEA	Spain	LX.AV 30J.06 2	AS5051AW XMi MCEESJ UMAC 2*512/120/ 6L/ 5R_bg_0.3 C_AN	ATMK 36	N14.1 WXGA	SO512 MBII5	SO512 MBII5	N120 GB5.4 K	NSM8 X	ABT_BRM4 318BG	N	N
AS5051AWX Mi	EMEA	Germany	LX.AV 30J.06 4	AS5051AW XMi MCEDEA UMAC 2*512/120/ 6L/ 5R_bg_0.3 C_AN	ATMK 36	N14.1 WXGA	SO512 MBII5	SO512 MBII5	N120 GB5.4 K	NSM8 X	ABT_BRM4 318BG	N	N
AS5051AWX Mi	EMEA	Germany	LX.AV 30J.06 5	AS5051AW XMi MCEDEB UMAC 2*512/120/ 6L/ 5R_bg_0.3 C_AN	ATMK 36	N14.1 WXGA	SO512 MBII5	SO512 MBII5	N120 GB5.4 K	NSM8 X	ABT_BRM4 318BG	N	N
AS5051AWX Mi	EMEA	Middle East	LX.AV 30J.07 0	AS5051AW XMi MCEAR1 UMAC 2*512/120/ 6L/ 5R_bg_0.3 C_AN	ATMK 36	N14.1 WXGA	SO512 MBII5	SO512 MBII5	N120 GB5.4 K	NSM8 X	ABT_BRM4 318BG	N	N
AS5051AWX Mi	EMEA	Middle East	LX.AV 30J.08 4	AS5051AW XMi MCEAR2 UMAC 2*512/120/ 6L/ 5R_bg_0.3 C_AN	ATMK 36	N14.1 WXGA	SO512 MBII5	SO512 MBII5	N120 GB5.4 K	NSM8 X	ABT_BRM4 318BG	N	N
AS5051AWX Mi	EMEA	Belgium	LX.AV 30J.06 6	AS5051AW XMi MCEBE6 UMAC 2*512/120/ 6L/ 5R_bg_0.3 C_AN	ATMK 36	N14.1 WXGA	SO512 MBII5	SO512 MBII5	N120 GB5.4 K	NSM8 X	ABT_BRM4 318BG	N	N
AS5051AWX Mi	EMEA	Eastern Europe	LX.AV 30J.07 9	AS5051AW XMi MCECS5 UMAC 2*512/120/ 6L/ 5R_bg_0.3 C_AN	ATMK 36	N14.1 WXGA	SO512 MBII5	SO512 MBII5	N120 GB5.4 K	NSM8 X	ABT_BRM4 318BG	N	N

Model	RO	Country	Acer Part no	Description	CPU	LCD	DIMM 1	DIMM 2	HDD 1 (GB)	ODD	Wireless LAN	Bluetooth	VOIP Phone
AS5051AWX Mi	EMEA	Holland	LX.AV 30J.069	AS5051AW XMi MCENL6 UMAC 2*512/120/6L/ 5R_bg_0.3 C_AN	ATMK 36	N14.1 WXGA	SO512 MBII5	SO512 MBII5	N120 GB5.4 K	NSM8 X	ABT_BRM4 318BG	N	N
AS5051AWX Mi	EMEA	Italy	LX.AV 30J.071	AS5051AW XMi MCEIT7 UMAC 2*512/120/6L/ 5R_bg_0.3 C_AN	ATMK 36	N14.1 WXGA	SO512 MBII5	SO512 MBII5	N120 GB5.4 K	NSM8 X	ABT_BRM4 318BG	N	N
AS5051AWX Mi	EMEA	Denmark	LX.AV 30J.074	AS5051AW XMi MCEDK6 UMAC 2*512/120/6L/ 5R_bg_0.3 C_AN	ATMK 36	N14.1 WXGA	SO512 MBII5	SO512 MBII5	N120 GB5.4 K	NSM8 X	ABT_BRM4 318BG	N	N
AS5051AWX Mi	EMEA	France	LX.AV 30J.063	AS5051AW XMi MCEFRF UMAC 2*512/120/6L/ 5R_bg_0.3 C_AN	ATMK 36	N14.1 WXGA	SO512 MBII5	SO512 MBII5	N120 GB5.4 K	NSM8 X	ABT_BRM4 318BG	N	N
AS5051AWX Mi	EMEA	Norway	LX.AV 30J.073	AS5051AW XMi MCENO5 UMAC 1*512/80/6L/ 5R_bg_0.3 C_AN	ATMK 36	N14.1 WXGA	SO512 MBII6	N	N80GB5.4K	NSM8 X	ABT_BRM4 318BG	N	N
AS5051AWX Mi	EMEA	Norway	LX.AV 30J.075	AS5051AW XMi MCENO5 UMAC 2*512/120/6L/ 5R_bg_0.3 C_AN	ATMK 36	N14.1 WXGA	SO512 MBII5	SO512 MBII5	N120 GB5.4 K	NSM8 X	ABT_BRM4 318BG	N	N
AS5051AWX Mi	EMEA	Russia	LX.AV 30J.080	AS5051AW XMi MCERU9 UMAC 2*512/120/6L/ 5R_bg_0.3 C_AN	ATMK 36	N14.1 WXGA	SO512 MBII5	SO512 MBII5	N120 GB5.4 K	NSM8 X	ABT_BRM4 318BG	N	N
AS5051AWX Mi	EMEA	Slovenia/Croatia	LX.AV 30J.085	AS5051AW XMi MCES11 UMAC 2*512/120/6L/ 5R_bg_0.3 C_AN	ATMK 36	N14.1 WXGA	SO512 MBII5	SO512 MBII5	N120 GB5.4 K	NSM8 X	ABT_BRM4 318BG	N	N
AS5051AWX Mi	EMEA	Switzerland	LX.AV 30J.086	AS5051AW XMi MCESW8 UMAC 2*512/120/6L/ 5R_bg_0.3 C_AN	ATMK 36	N14.1 WXGA	SO512 MBII5	SO512 MBII5	N120 GB5.4 K	NSM8 X	ABT_BRM4 318BG	N	N



Model	RO	Country	Acer Part no	Description	CPU	LCD	DIMM 1	DIMM 2	HDD 1 (GB)	ODD	Wireless LAN	Bluetooth	VOIP Phone
AS5051AWX Mi	EMEA	Eastern Europe	LX.AV 30J.068	AS5051AW XMi MCEPL7 UMAC 2*512/120/6L/ 5R_bg_0.3 C_AN	ATMK 36	N14.1 WXGA	SO512 MBII5	SO512 MBII5	N120 GB5.4 K	NSM8 X	ABT_BRM4 318BG	N	N
AS5051AWX Mi	EMEA	Sweden/Finland	LX.AV 30J.067	AS5051AW XMi MCESV5 UMAC 2*512/120/6L/ 5R_bg_0.3 C_AN	ATMK 36	N14.1 WXGA	SO512 MBII5	SO512 MBII5	N120 GB5.4 K	NSM8 X	ABT_BRM4 318BG	N	N
AS5051AWX Mi	EMEA	UK	LX.AV 30J.081	AS5051AW XMi MCEUUK1 1U UMAC 2*512/120/6L/ 5R_bg_0.3 C_AN	ATMK 36	N14.1 WXGA	SO512 MBII5	SO512 MBII5	N120 GB5.4 K	NSM8 X	ABT_BRM4 318BG	N	N
AS5051AWX Mi	EMEA	UK	LX.AV 30J.087	AS5051AW XMi MCEUK5 UMAC 2*512/120/6L/ 5R_bg_0.3 C_AN	ATMK 36	N14.1 WXGA	SO512 MBII5	SO512 MBII5	N120 GB5.4 K	NSM8 X	ABT_BRM4 318BG	N	N
AS5051AWX Mi	EMEA	Turkey	LX.AV 30J.072	AS5051AW XMi MCETR5 UMAC 2*512/120/6L/ 5R_bg_0.3 C_AN	ATMK 36	N14.1 WXGA	SO512 MBII5	SO512 MBII5	N120 GB5.4 K	NSM8 X	ABT_BRM4 318BG	N	N
AS5051AWX Mi	EMEA	Italy	LX.AV 30J.076	AS5051AW XMi MCEWIT11 W UMAC 2*512/120/6L/ 5R_bg_0.3 C_AN	ATMK 36	N14.1 WXGA	SO512 MBII5	SO512 MBII5	N120 GB5.4 K	NSM8 X	ABT_BRM4 318BG	N	N
AS5051AWX Mi	EMEA	UK	LX.AV 30J.088	AS5051AW XMi MCEUK6 UMAC 2*512/120/6L/ 5R_bg_0.3 C_AN	ATMK 36	N14.1 WXGA	SO512 MBII5	SO512 MBII5	N120 GB5.4 K	NSM8 X	ABT_BRM4 318BG	N	N
AS5051AWX Mi	EMEA	France	LX.AV 30J.077	AS5051AW XMi MCEWFR1 1W UMAC 2*512/120/6L/ 5R_bg_0.3 C_AN	ATMK 36	N14.1 WXGA	SO512 MBII5	SO512 MBII5	N120 GB5.4 K	NSM8 X	ABT_BRM4 318BG	N	N
AS5051AWX Mi	EMEA	Germany	LX.AV 30J.078	AS5051AW XMi MCEWDE1 1W UMAC 2*512/120/6L/ 5R_bg_0.3 C_AN	ATMK 36	N14.1 WXGA	SO512 MBII5	SO512 MBII5	N120 GB5.4 K	NSM8 X	ABT_BRM4 318BG	N	N

Model	RO	Country	Acer Part no	Description	CPU	LCD	DIMM 1	DIMM 2	HDD 1 (GB)	ODD	Wireless LAN	Bluetooth	VOIP Phone
AS5051AWX Mi	EMEA	Germany	LX.AV 305.057	AS5051AW XMi XPHDE7 UMAC 2*512/120/6L/ 5R_bg_0.3 C_AN	ATMK 36	N14.1 WXGA	SO512 MBII5	SO512 MBII5	N120 GB5.4 K	NSM8 X	ABT_BRM4 318BG	N	N
AS5051AWX Mi	EMEA	Middle East	LX.AV 305.061	AS5051AW XMi XPHAR1 UMAC 2*512/120/6L/ 5R_bg_0.3 C_AN	ATMK 36	N14.1 WXGA	SO512 MBII5	SO512 MBII5	N120 GB5.4 K	NSM8 X	ABT_BRM4 318BG	N	N
AS5051AWX Mi	EMEA	Denmark	LX.AV 305.047	AS5051AW XMi XPHDK1 UMAC 2*512/120/6L/ 5R_bg_0.3 C_AN	ATMK 36	N14.1 WXGA	SO512 MBII5	SO512 MBII5	N120 GB5.4 K	NSM8 X	ABT_BRM4 318BG	N	N
AS5051AWX Mi	EMEA	Belgium	LX.AV 305.056	AS5051AW XMi XPHBE1 UMAC 2*512/120/6L/ 5R_bg_0.3 C_AN	ATMK 36	N14.1 WXGA	SO512 MBII5	SO512 MBII5	N120 GB5.4 K	NSM8 X	ABT_BRM4 318BG	N	N
AS5051AWX Mi	EMEA	Eastern Europe	LX.AV 305.052	AS5051AW XMi XPHCS2 UMAC 2*512/120/6L/ 5R_bg_0.3 C_AN	ATMK 36	N14.1 WXGA	SO512 MBII5	SO512 MBII5	N120 GB5.4 K	NSM8 X	ABT_BRM4 318BG	N	N
AS5051AWX Mi	EMEA	UK	LX.AV 30J.083	AS5051AW XMi MCEWUK1 1W UMAC 2*512/120/6L/ 5R_bg_0.3 C_AN	ATMK 36	N14.1 WXGA	SO512 MBII5	SO512 MBII5	N120 GB5.4 K	NSM8 X	ABT_BRM4 318BG	N	N
AS5051AWX Mi	EMEA	UK	LX.AV 30J.082	AS5051AW XMi MCEWUK2 1W UMAC 2*512/120/6L/ 5R_bg_0.3 C_AN	ATMK 36	N14.1 WXGA	SO512 MBII5	SO512 MBII5	N120 GB5.4 K	NSM8 X	ABT_BRM4 318BG	N	N
AS5051AWX Mi	EMEA	Eastern Europe	LX.AV 305.051	AS5051AW XMi XPHHU6 UMAC 2*512/120/6L/ 5R_bg_0.3 C_AN	ATMK 36	N14.1 WXGA	SO512 MBII5	SO512 MBII5	N120 GB5.4 K	NSM8 X	ABT_BRM4 318BG	N	N
AS5051AWX Mi	EMEA	Spain	LX.AV 305.059	AS5051AW XMi XPHESA UMAC 2*512/120/6L/ 5R_bg_0.3 C_AN	ATMK 36	N14.1 WXGA	SO512 MBII5	SO512 MBII5	N120 GB5.4 K	NSM8 X	ABT_BRM4 318BG	N	N

Model	RO	Country	Acer Part no	Description	CPU	LCD	DIMM 1	DIMM 2	HDD 1 (GB)	ODD	Wireless LAN	Bluetooth	VOIP Phone
AS5051AWX Mi	EMEA	Greece	LX.AV 305.054	AS5051AW XMi XPHL1 UMAC 2*512/120/6L/ 5R_bg_0.3 C_AN	ATMK 36	N14.1 WXGA	SO512 MBII5	SO512 MBII5	N120 GB5.4 K	NSM8 X	ABT_BRM4 318BG	N	N
AS5051AWX Mi	EMEA	Israel	LX.AV 305.069	AS5051AW XMi XPHIS1 UMAC 2*512/120/6L/ 5R_bg_0.3 C_AN	ATMK 36	N14.1 WXGA	SO512 MBII5	SO512 MBII5	N120 GB5.4 K	NSM8 X	ABT_BRM4 318BG	N	N
AS5051AWX Mi	EMEA	France	LX.AV 305.048	AS5051AW XMi XPHFRA UMAC 2*512/120/6L/ 5R_bg_0.3 C_AN	ATMK 36	N14.1 WXGA	SO512 MBII5	SO512 MBII5	N120 GB5.4 K	NSM8 X	ABT_BRM4 318BG	N	N
AS5051AWX Mi	EMEA	Italy	LX.AV 305.055	AS5051AW XMi XPHIT1 UMAC 2*512/120/6L/ 5R_bg_0.3 C_AN	ATMK 36	N14.1 WXGA	SO512 MBII5	SO512 MBII5	N120 GB5.4 K	NSM8 X	ABT_BRM4 318BG	N	N
AS5051AWX Mi	EMEA	Eastern Europe	LX.AV 305.053	AS5051AW XMi XPHPL6 UMAC 2*512/120/6L/ 5R_bg_0.3 C_AN	ATMK 36	N14.1 WXGA	SO512 MBII5	SO512 MBII5	N120 GB5.4 K	NSM8 X	ABT_BRM4 318BG	N	N
AS5051AWX Mi	EMEA	Holland	LX.AV 305.067	AS5051AW XMi XPHNL1 UMAC 2*512/120/6L/ 5R_bg_0.3 C_AN	ATMK 36	N14.1 WXGA	SO512 MBII5	SO512 MBII5	N120 GB5.4 K	NSM8 X	ABT_BRM4 318BG	N	N
AS5051AWX Mi	AAP	Malaysia	LX.AV 305.066	AS5051AW XMi XPHMA2 UMAC 1*512/80/6L/5R/ CB_bg_0.3 C_AN	ATMK 36	N14.1 WXGA G	SO512 MBII5	N	N80G B5.4K	NSM8 X	ABT_ATH54 13BG	N	N
AS5051AWX Mi	EMEA	Norway	LX.AV 305.058	AS5051AW XMi XPHNO1 UMAC 2*512/120/6L/ 5R_bg_0.3 C_AN	ATMK 36	N14.1 WXGA	SO512 MBII5	SO512 MBII5	N120 GB5.4 K	NSM8 X	ABT_BRM4 318BG	N	N
AS5051AWX Mi	EMEA	South Africa	LX.AV 305.062	AS5051AW XMi XPHSA1 UMAC 2*512/120/6L/ 5R_bg_0.3 C_AN	ATMK 36	N14.1 WXGA	SO512 MBII5	SO512 MBII5	N120 GB5.4 K	NSM8 X	ABT_BRM4 318BG	N	N

Model	RO	Country	Acer Part no	Description	CPU	LCD	DIMM 1	DIMM 2	HDD 1 (GB)	ODD	Wireless LAN	Bluetooth	VOIP Phone
AS5051AWX Mi	EMEA	Russia	LX.AV 305.049	AS5051AW XMi XPHRU2 UMAC 2*512/120/6L/ 5R_bg_0.3 C_AN	ATMK 36	N14.1 WXGA	SO512 MBII5	SO512 MBII5	N120 GB5.4 K	NSM8 X	ABT_BRM4 318BG	N	N
AS5051AWX Mi	EMEA	Sweden/ Finland	LX.AV 305.050	AS5051AW XMi XPHSV1 UMAC 2*512/120/6L/ 5R_bg_0.3 C_AN	ATMK 36	N14.1 WXGA	SO512 MBII5	SO512 MBII5	N120 GB5.4 K	NSM8 X	ABT_BRM4 318BG	N	N
AS5051AWX Mi	EMEA	Slovenia/ Croatia	LX.AV 305.063	AS5051AW XMi XPHSLO2 UMAC 2*512/120/6L/ 5R_bg_0.3 C_AN	ATMK 36	N14.1 WXGA	SO512 MBII5	SO512 MBII5	N120 GB5.4 K	NSM8 X	ABT_BRM4 318BG	N	N
AS5051AWX Mi	EMEA	Portugal	LX.AV 305.068	AS5051AW XMi XPHPT1 UMAC 2*512/120/6L/ 5R_bg_0.3 C_AN	ATMK 36	N14.1 WXGA	SO512 MBII5	SO512 MBII5	N120 GB5.4 K	NSM8 X	ABT_BRM4 318BG	N	N
AS5051AWX Mi	EMEA	Switzerland	LX.AV 305.064	AS5051AW XMi XPHSW5 UMAC 2*512/120/6L/ 5R_bg_0.3 C_AN	ATMK 36	N14.1 WXGA	SO512 MBII5	SO512 MBII5	N120 GB5.4 K	NSM8 X	ABT_BRM4 318BG	N	N
AS5051AWX Mi	EMEA	UK	LX.AV 305.065	AS5051AW XMi XPHUK1 UMAC 2*512/120/6L/ 5R_bg_0.3 C_AN	ATMK 36	N14.1 WXGA	SO512 MBII5	SO512 MBII5	N120 GB5.4 K	NSM8 X	ABT_BRM4 318BG	N	N
AS5051AWX Mi	EMEA	Turkey	LX.AV 305.070	AS5051AW XMi XPHTR1 UMAC 2*512/120/6L/ 5R_bg_0.3 C_AN	ATMK 36	N14.1 WXGA	SO512 MBII5	SO512 MBII5	N120 GB5.4 K	NSM8 X	ABT_BRM4 318BG	N	N
AS5051ANW XMi	EMEA	Turkey	LX.AV 30C.025	AS5051AN WXMi LINPUSTR 1 UMAC 1*512/60/6L/5R/ CB_bg_0.3 C_AN	ATMK 36	N14.1 WXGA G	SO512 MBII5	N	N60G B5.4K	NSM8 X	ABT_BRM4 318BG	N	N
AS5051AWX Mi	EMEA	Turkey	LX.AV 305.071	AS5051AW XMi XPHTR1 UMAC 1*512/60/6L/5R/ CB_bg_0.3 C_AN	ATMK 36	N14.1 WXGA G	SO512 MBII5	N	N60G B5.4K	NSM8 X	ABT_BRM4 318BG	N	N

Model	RO	Country	Acer Part no	Description	CPU	LCD	DIMM 1	DIMM 2	HDD 1 (GB)	ODD	Wireless LAN	Bluetooth	VOIP Phone
AS5052NWXMi	AAP	India	LX.AV30C.026	AS5052N WXMi LINPUSIL1 UMAC 1*512/80/ BT/6L/5R/ CB_bg_0.3 C_AN	ATTL50	N14.1 WXGAG	SO512 MBII5	N	N80G B5.4K	NSM8 X	ABT_ ATH54 13BG	FOX_ BRM_ 2.0	N



# Test Compatible Components

---

This computer's compatibility is tested and verified by Acer's internal testing department. All of its system functions are tested under Windows® XP Home, Windows® XP Pro environment.

Refer to the following lists for components, adapter cards, and peripherals which have passed these tests. Regarding configuration, combination and test procedures, please refer to the TravelMate 7520/7520G/7220 Series and Aspire 7420/7120 Series Compatibility Test Report released by the Acer Mobile System Testing Department.

# Microsoft® Windows® Vista Environment Test

Item	Device Name
<b>CRT Port Test</b>	
CRT Monitor	Acer 211c 21", ViewSonic G220F, ViewSonic PF790 19", Sony TV Trinitron (S-Video)
LCD Monitor	Acer FP751 17" TFT LCD, Acer AL1521, Acer AL1721, ViewSonic VD201b, Westinghouse W37G, HP LP2065, HP S9500
Projector	Dell 3300MP
<b>USB Port Test</b>	
USB Keyboard/Mouse	Microsoft Natural Keyboard Pro Dell USB Keyboard Logicool USB Mouse (OWCM-USB) Logitech USB Wheel Mouse Logitech First Wheel Mouse Dell Dell by Logitech Dell Internet Navigator Keyboard Dell Smart Card Keyboard HP USB Optical Austin Mouse Belkin Miniglow Optical USB Mouse HP USB Optical Mouse (RB129AA)
USB Speaker/Joystick	Aiwa Multimedia Digital Speaker (SC-UC78) Logitech WingMan RumblePad (G-UA3) Peripheral Dolby Headphone 5.1 Channel Panasonic USB Speaker EAB-MPC57USB JS iFun USB Speaker
USB Storage Drive	Iomega USB Zip 250MB Fujitsu MO-1300 1.3 GB Transcend 80G HDD PQI 6-in-1 Flash Card Reader/Writer Plextor DVD+R/RW Galileo Mass Storage 2.5 Travel Kit (with 1394) LG DVD+R/RW Sony DVD+R/RW
USB Camera	Intel Easy PC Camera (A20953-001) Orange Micro USB 2.0 Web Cam
USB HUB and Others	A TEN UH-204 IOGEAR 4-Port Hub Corega CG-WLUSBST11
USB Printer/Scanner	Canon Scanner D1250 (JP OS only) HP 450WBT Deskjet Printer HP 2400 Scanjet
USB Flash Drive	Sony Memory Key 128MB Sony Micro Vault Pro USD-5G IBM 128MB Memory Key IBM 512MB Memory Key Apacer The USB Flash Drive 256MB
USB HDD	Transcend 2.5" Portable 80GB Hard Disk



Item	Device Name
USB ODD	Logitech CDRW+DVDROM combo LG DVD+R/RW Sony DVD+R/RW
<b>IR Test</b>	
IR Printer	HP LaserJet 2200 using IR HP 450wbt deskjet
IR Mobile Phone	Sony Ericsson T60 Motorola V600 Nokia 6820
<b>1394 Test</b>	
1394 Storage Drive	LG DVD+R/RW 16X Sony DVD+R/RW 16X Transcend 2.5" Portable 80GB Hard Disk
1394 Camera	Sony DV-TRV10
1394 Hub	ATEN FireWire Expansion HUB 6-Port IEEE 1394 Hub (FH-600)
Access Point 802.11a	Intel Pro/Wireless 5000 NetGear 54Mbps 802.11a Access Point Model: HE 102
Access Point 802.11b	Cisco Aironet 350 Cisco Aironet 1230
Access Point 802.11g	D-Link Building Networks People WiFi Certified a/b/g Wireless 108AG
Access Point 802.11n	D-Link Rangebooster N 650 Router Wireless-108.11n Buffalo Air Station Wireless IEEE 802.11n/g/b (WZR-G144N) Belkin N1MIMO Wireless Router High Performance Wireless-802.11n
<b>Bluetooth Test</b>	
Bluetooth Device	Sony Ericsson Wireless Headset Sony Ericsson T610 X Bridge Bluetooth Access Point BT300 Epson Bluetooth Print Adapter HP Deskjet 450wbt AmbiCom Bluetooth Wireless CompactFlash Card with PC Card Adapter
<b>PCMCIA Test</b>	
LAN/Modem Card	TDK CardBus Ethernet 10/100 32-Bit CBE-10/100BTX
Storage Card	Hitachi Microdrive 4G Iomega Click! 40MB
1394 Card	Buffalo 1394 Interface Cardbus (IFC-ILCB/DV) I-O Data 1394 Interface Cardbus (CB1394/DVC)
USB2.0 Card	IBM EtherJet CardBus Adapter 10/100 Adaptec USB2 Connect IOGEAR Cardbus Card USB 2.0
GPRS Card	Vodafone QL1ACC-21581 3G/GPRS card Sony Ericsson GC83 GPRS card Sony Ericsson GC89 GPRS card
<b>ExpressCard Test</b>	
Express Card	Abcom 5-in-1 Adapter ExpressCard Reader Abcom GigaLan ExpressCard Sunix ECF2400 2 Ports 1394A ExpressCard Sunix Serial ATA External SATAII ExpressCard IK KOUWELL IEEE 1394+USB 2.0 ExpressCard SIIG ExpressCard 11-in-1 R/W

Item	Device Name
<b>Memory Card Test (SD/MS/MMC/SM/CF/Microdrive/XD)</b>	
SD Card	Apacer 128/256MB Transcend 256MB SanDisk 256MB Apacer 2GB (150x Hi-Speed) KINGMAX 1GB (66x Hi-Speed) SanDisk 1GB RiDATA 4GB SD PRO Memory Card
MS Card	I-O DATA 64MB MS Apacer 128MB MS Sony 512 MS PRO Lexar 512MB MS PRO Lexar 1GB MS PRO SanDisk 1GB MS PRO Sony 2GB MS PRO Duo High Speed Sony 2GB MS PRO
MMC Card	SanDisk 32MB Transcend 64/128MB Apacer 128MB Transcend 256MB SanDisk RS-MMC 128MB PQI RS-MMC 256MB Transcend 512MB A-DATA Turbo 200X 2GB MMC Card
XD Card	Apacer 256/512MB SanDisk 2GB Olympus 512MB

# Online Support Information

---

This section describes online technical support services available to help you repair your Acer Systems.

If you are a distributor, dealer, ASP or TPM, please refer your technical queries to your local Acer branch office. Acer Branch Offices and Regional Business Units may access our website. However some information sources will require a user i.d. and password. These can be obtained directly from Acer CSD Taiwan.

Acer's Website offers you convenient and valuable support resources whenever you need them.

In the Technical Information section you can download information on all of Acer's Notebook, Desktop and Server models including:

- Service guides for all models
- User's manuals
- Training materials
- Bios updates
- Software utilities
- Spare parts lists
- TABs (Technical Announcement Bulletin)

For these purposes, we have included an Acrobat File to facilitate the problem-free downloading of our technical material.

Also contained on this website are:

- Detailed information on Acer's International Traveler's Warranty (ITW)
- Returned material authorization procedures
- An overview of all the support services we offer, accompanied by a list of telephone, fax and email contacts for all your technical queries.

We are always looking for ways to optimize and improve our services, so if you have any suggestions or comments, please do not hesitate to communicate these to us.



**A**

AFLASH Utility 53  
 Antennas 100  
 Audio 35

**B**

Battery Pack 62  
 BIOS 31
 

- package 31
- password control 31
- ROM size 31
- ROM type 31
- vendor 31
- Version 31

 BIOS Supports protocol 31  
 BIOS Utility 41–53
 

- Navigating 42
- Onboard Device Configuration 48
- Security 45, 47
- System Security 52

 Board Layout
 

- Top View 123

 brightness
 

- hotkeys 16

**C**

Cache
 

- controller 31
- size 31

 caps lock
 

- on indicator 10

 CardBus 36  
 computer
 

- on indicator 10

 CPU 76  
 CPU Fan True Value Table 31

**D**

DIMM Module 68  
 Display 4  
 display
 

- hotkeys 16

**E**

Error Symptom-to-Spare Part Index 108  
 Euro 17  
 External CD-ROM Drive Check 104  
 External Module Disassembly  
 Flowchart 61

**F**

Features 1  
 Flash Utility 53  
 fpc cable 98  
 FRU (Field Replaceable Unit) List 129

**H**

Hard disk 33  
 Hard Disk Drive Module 69  
 HDD 33  
 Heatsink Module 74  
 Hibernation mode
 

- hotkey 16

 Hot Keys 14

**I**

Indicators 10  
 Intermittent Problems 121  
 internal mic and web camera 101  
 inverter board 98

**J**

Jumper and Connector Locations 123  
 Top View 123

**K**

Keyboard 37, 79  
 Keyboard or Auxiliary Input Device Check  
 104

**L**

Launch Board 85  
 LCD Bezel 96

---

LCD Brackets 99  
LCD Module Disassembly  
    Flowchart 95  
LCD with the Brackets 97  
lower cover 64

## M

Main Unit Disassembly  
    Flowchart 73  
Mainboard 89  
media access  
    on indicator 10  
Memory Check 105  
Middle Cover and Power Board 78  
Model Definition 140  
Modem Board 73

## N

Notebook Manager  
    hotkey 16  
num lock  
    on indicator 10

## O

Online Support Information 167  
optical drive module 70

## P

Panel 5  
    Bottom 9  
    left 5  
PC Card 10, 36  
PCMCIA 36  
Power System Check 105  
    Battery Pack 107  
    Power Adapter 106  
Processor 31

## S

sata connector 66  
Screw List 60, 61, 73, 95  
secondary hdd bracket 66  
Speaker Module 92

speakers  
    hotkey 16  
System  
    Block Diagram 4  
System Check Procedures 104  
System Memory 32  
System Utilities 41

## T

Test Compatible Components 163  
Top 123  
Touch Pad Board 86  
touchpad  
    hotkey 16  
Touchpad Check 107  
Troubleshooting 103

## U

Undetermined Problems 122  
USB Board 93  
utility  
    BIOS 41–53

## V

Video 36

## W

Windows 2000 Environment Test 164  
WLAN Board 68